

CONTEMPORARY MOULDINGS

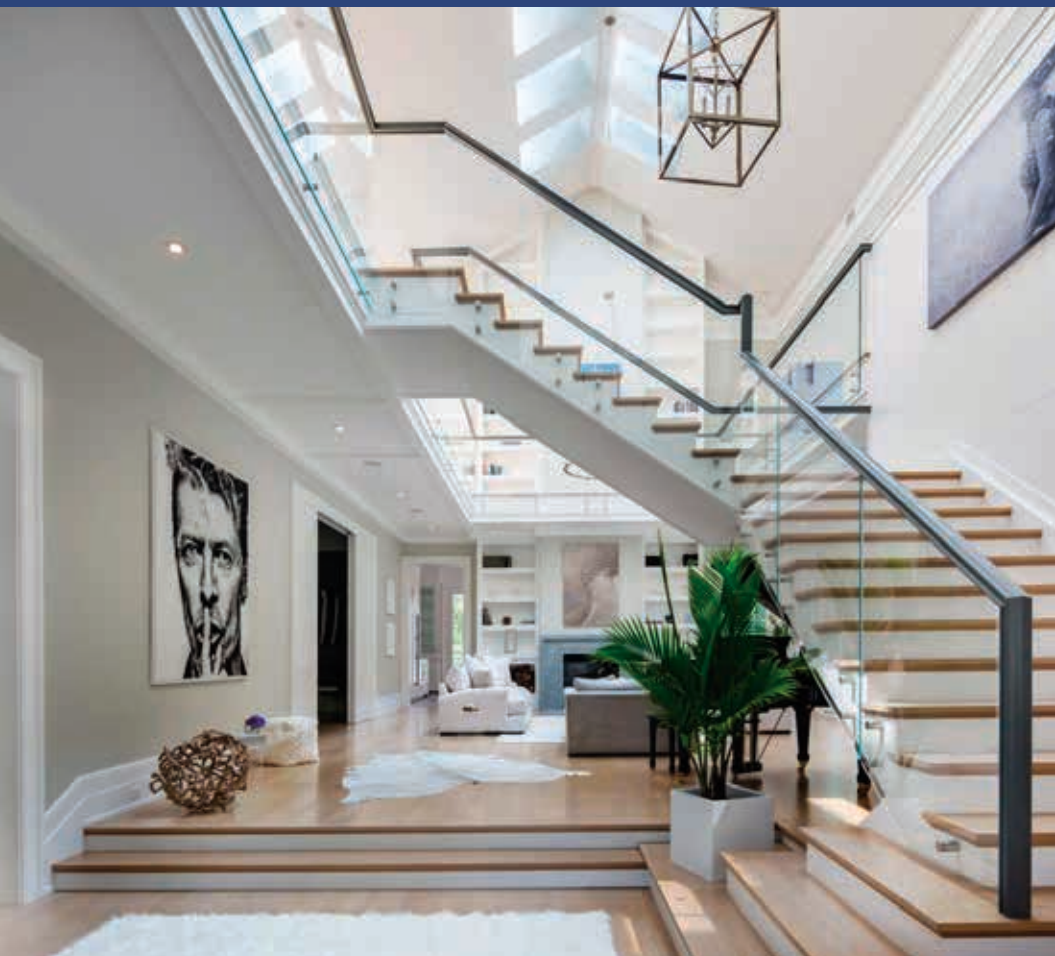

ALAN McILVAIN COMPANY

Hardwood Lumber & Custom Mouldings Since 1798



History of McIlvain

When Hugh McIlvain, a Quaker of Scotch-Irish descent, opened a lumber yard in Philadelphia in 1798, it's likely he didn't realize he was founding what would become one of the longest running family enterprises in American history. Sticking to his mission of providing only the highest quality hardwoods, and by working extremely hard, Hugh McIlvain was able to do just that.

The Embargo Act of 1807 cut off American ports and forced producers to ship all timber by canal and rail. The first canal/rail connection between Pittsburgh and Philadelphia was completed in 1834 and conveniently ended at McIlvain's doorstep (where Philadelphia's 30th Street Station stands today).

From the Civil War to the World Wars, through booms and busts, the McIlvains were part of the fiber of American industrial might. Philadelphia's ports and factories were preeminent in the world throughout the 19th and into the 20th centuries and McIlvain Lumber was there to do its part. It was McIlvain Lumber that helped build America's railroads and especially its railcars. McIlvain lumber was used for the construction of the University of Pennsylvania in 1872. McIlvain lumber is found in the White House, the Supreme Court and the United States Capital. Lumber was central to all manner of building and manufacturing and McIlvain was central to lumber.

In 1906 a fire consumed the yard and 12 million board feet of lumber. It burned so brightly that its glow was clearly visible 60 miles away in Atlantic City, NJ. Left with nothing but their grit and an inbound train of lumber which was spared from the fire, the McIlvains got back to work rebuilding and overcame such a disaster.

When the company approached its 100-year anniversary, a Centennial celebration was held. The New York Lumber Trades Journal said, "This is the only instance of the kind in the United States of a lumber company 100 years old at least by succession in direct line...what the family does not know about lumber is certainly not worth studying. Some lumbermen come and go, but McIlvains got on forever."

Over 220 years since its founding, the McIlvains are still committed to the mission of providing only the highest quality products and working hard. Today the 7th generation of McIlvain lumbermen are proving their strength and reliability in providing lumber and millwork all over the world.



About McIlvain

For over 200 years the Alan McIlvain Company has been producing and distributing the finest quality hardwood mouldings and lumber. Our experienced, dedicated employees use state of the art equipment to provide the highest quality, service and value in the industry.

Unlike most millwork suppliers Alan McIlvain Company specializes in premium, 100% solid wood custom run orders. From our large diversified rough lumber inventory, we can promptly produce the most demanding moulding orders. The profiles in this catalog are the most popular among the 35,000 plus knives we have in stock ready to run. Additionally, we offer custom CNC knife grinding to perfectly match any profile.

Alan McIlvain Company stocks over seven million board feet and 30 species of premium grade hardwood and softwood lumber. Northern Appalachian and imported hardwoods are sourced directly from sawmills and kiln dried on premises. All lumber is carefully inspected on a highly automated 30 bin sorter before and after kiln drying. Stock is then separated by width, length and grade and stored in climate-controlled warehouses.

For simply the best quality, service and value in mouldings and premium hardwoods - phone, e-mail or fax Alan McIlvain Company today!

Alan McIlvain, Jr. & Gordon W. McIlvain

ALAN McILVAIN, JR. GORDAN W. McILVAIN





Table of Contents

The History of Alan McIlvain Company	2
About Alan McIlvain Company	3
Casing.....	6
Chair Rail	12
Crown	14
Base	22
Panel Moulding	30
Shoe Moulding	32
Backband	33
Shiplap Moulding.....	35
Tongue & Groove Moulding	36
In-Stock Species	38
Millwork Services	39

Permission to use the copyrighted designs (shown with ©) in this catalog has been granted to Alan McIlvain Company by Brett Arrowood.



Casing

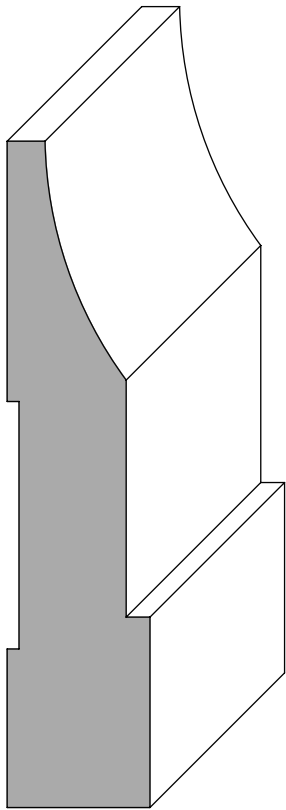

C501
3/4" x 3-1/2"

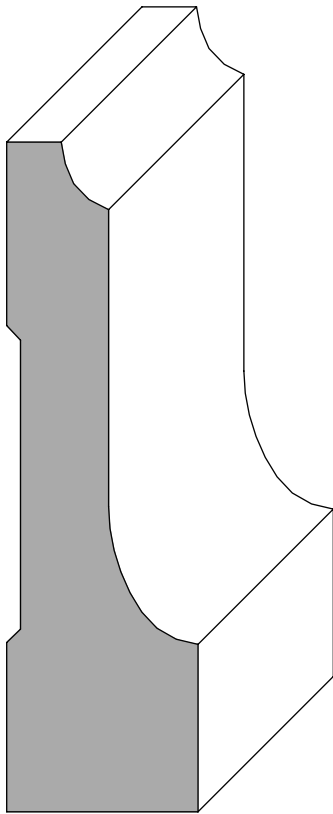

C510
1" x 3-1/2"

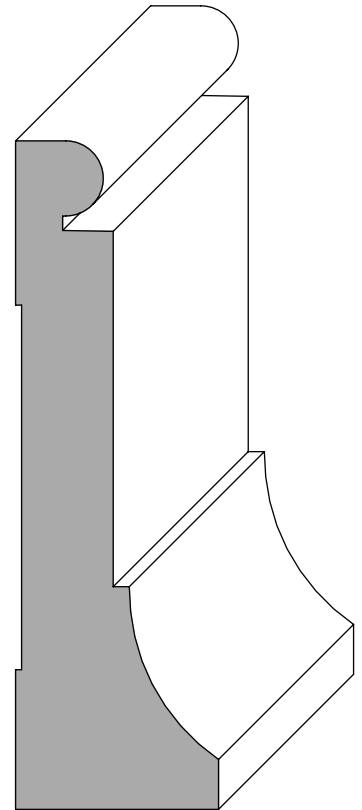

C511
1-1/16" x 3-1/2"

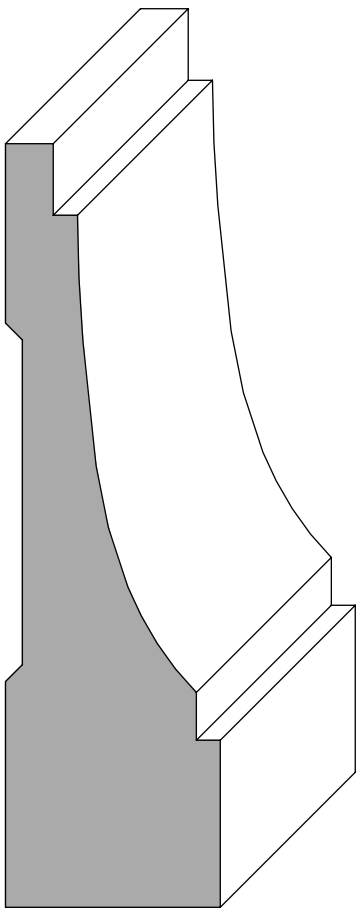

C506
1-1/8" x 4"

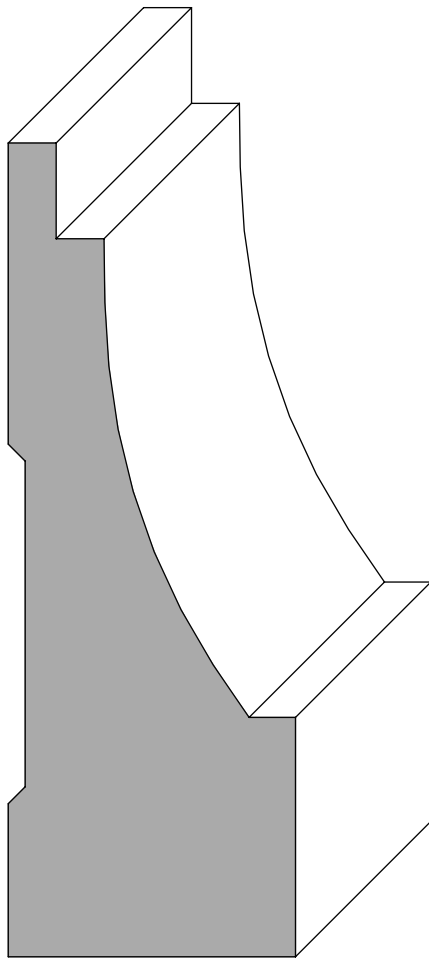

C505
1-1/2" x 4-1/4"

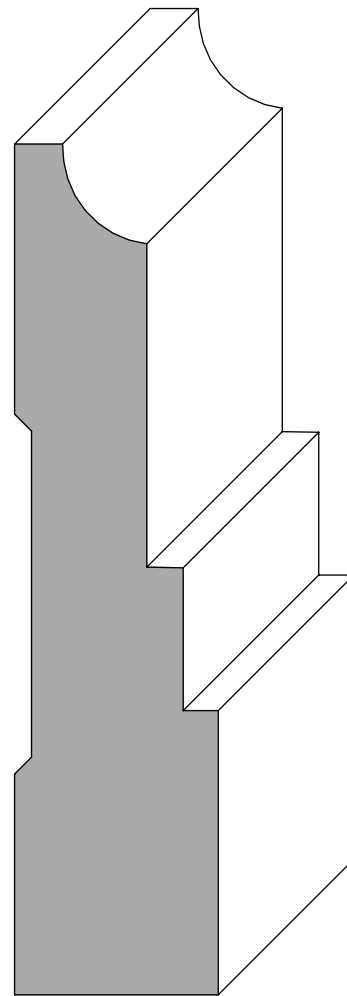

C514
1-1/16" x 4-7/16"

Casing

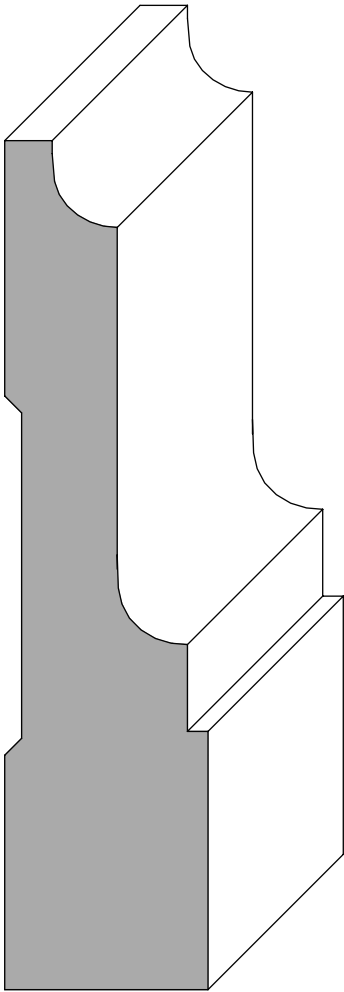

C515
1-1/16" x 4-7/16"

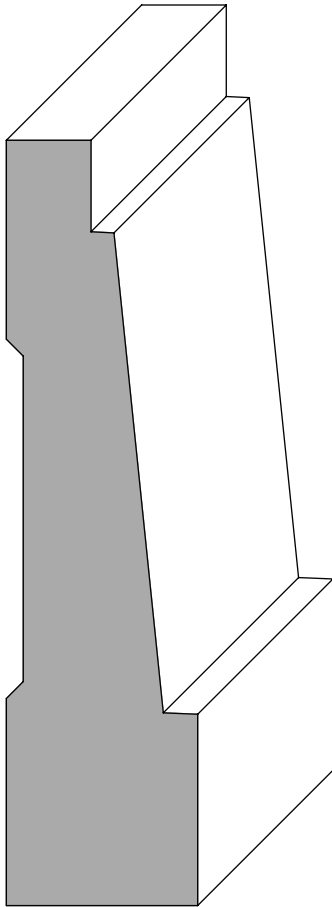

C526
1" x 4"

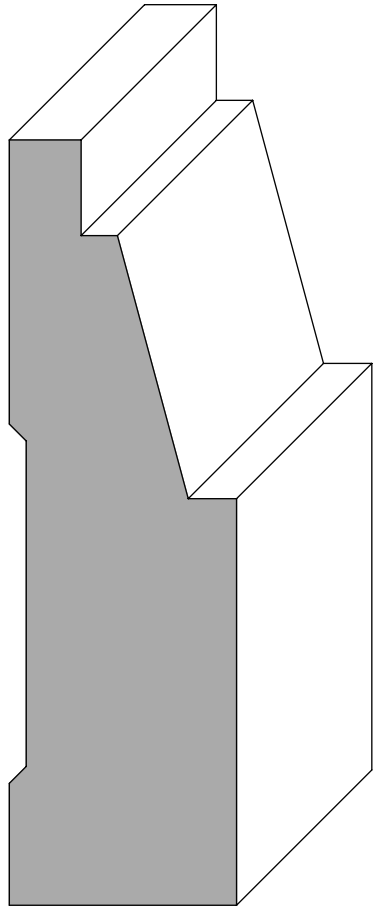

C532
1-3/16" x 4"

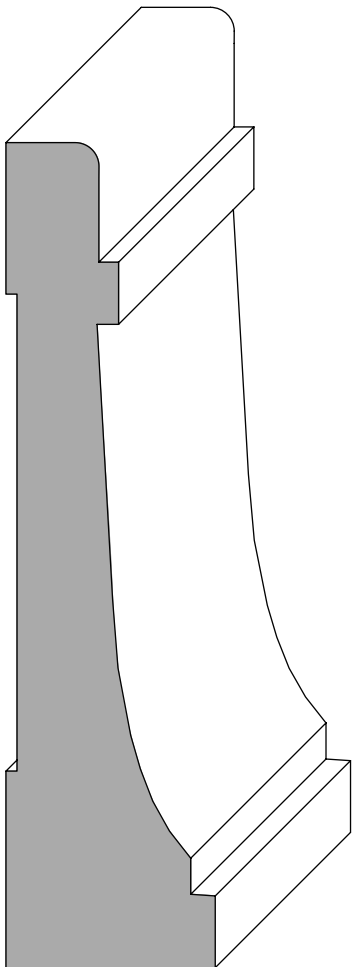

C535
1-1/8" x 4-5/16"

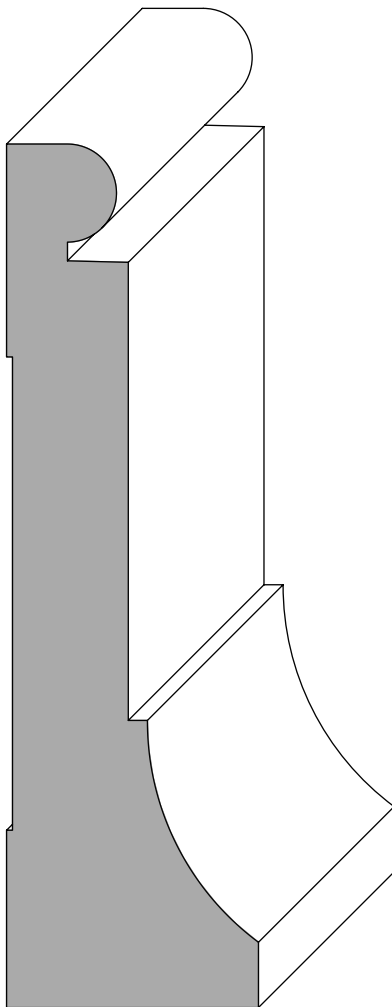

C536
1-5/16" x 4-1/2"

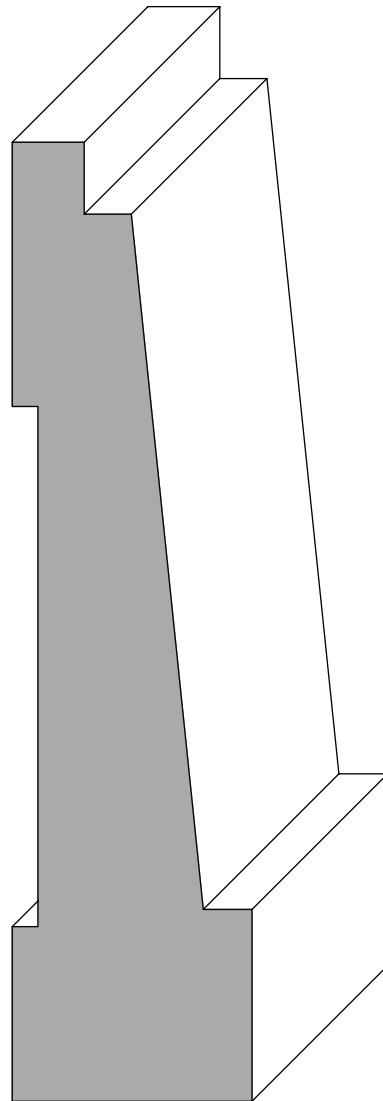

C542
1-1/4" x 5"

Casing

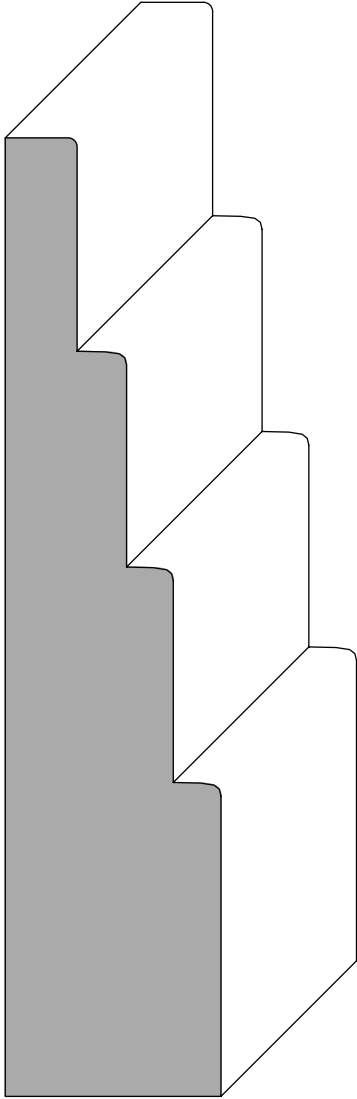

C544
1-1/8" x 5"

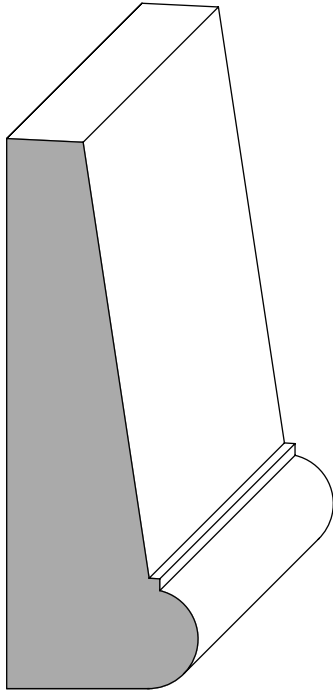

C555
1" x 2-7/8"

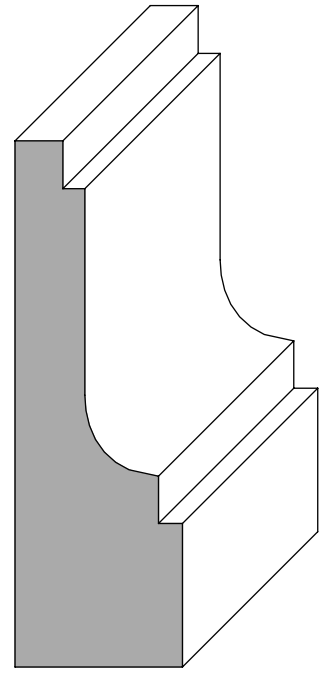

C556
7/8" x 2-3/4"

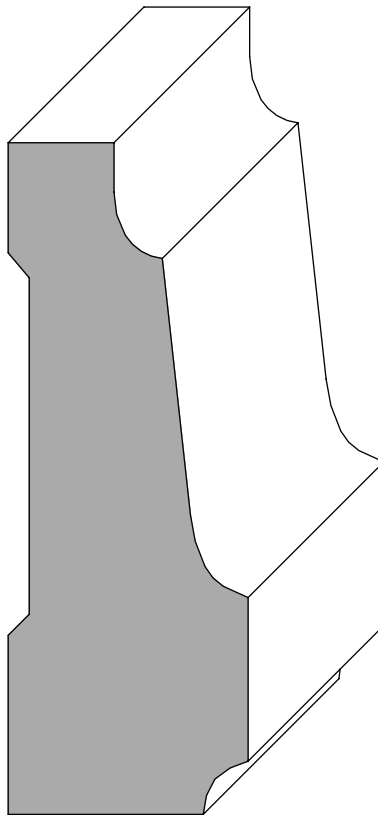

C561
1-1/4" x 3-1/2"

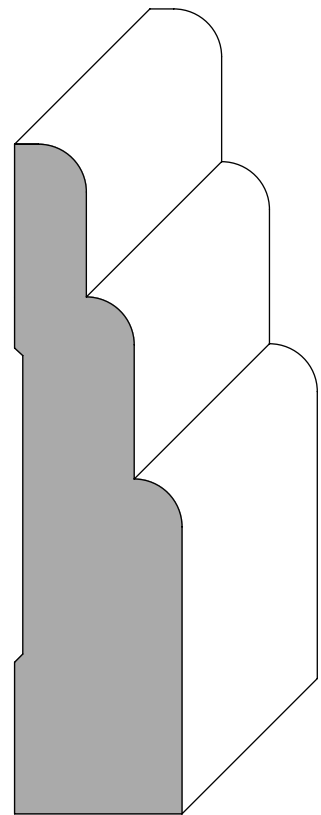

C563
7/8" x 3-1/2"

Casing

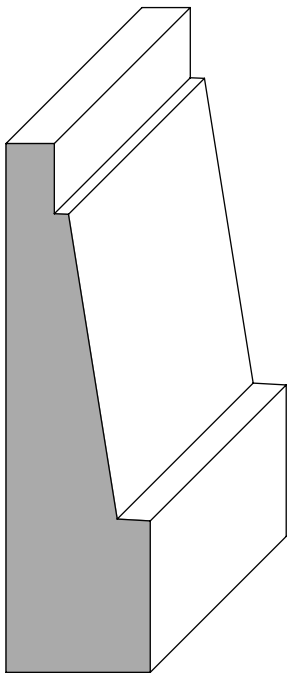

C557
3/4" x 2-3/4"

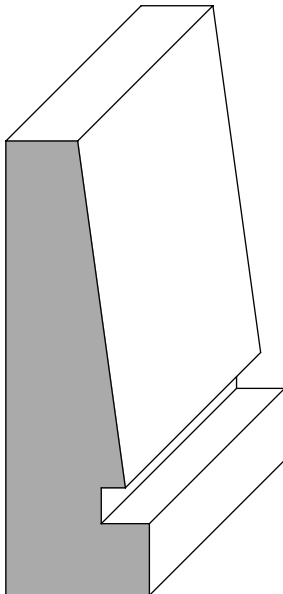

C560
3/4" x 2-3/8"

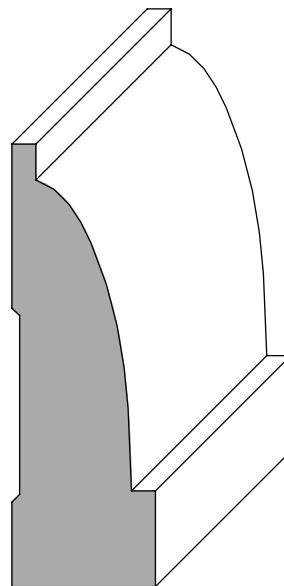

C562
3/4" x 2-5/16"

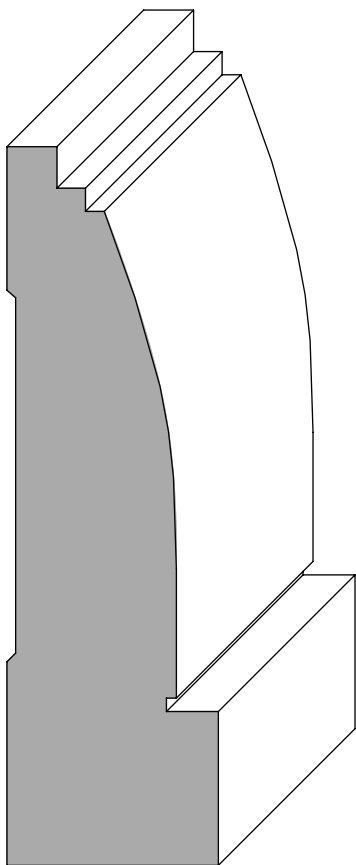

C564©
7/8" x 3-1/2"

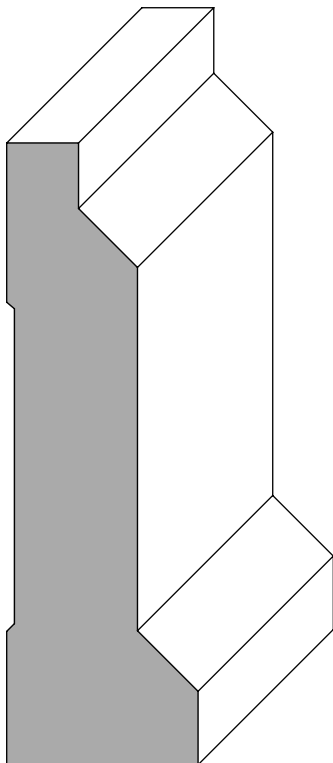

C565
1" x 3-1/4"

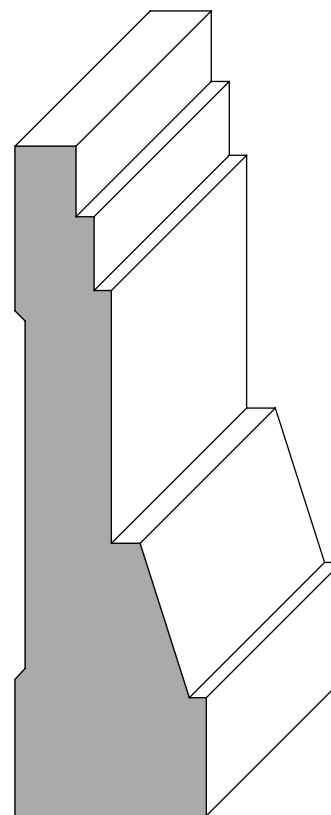

C566©
1" x 3-1/2"

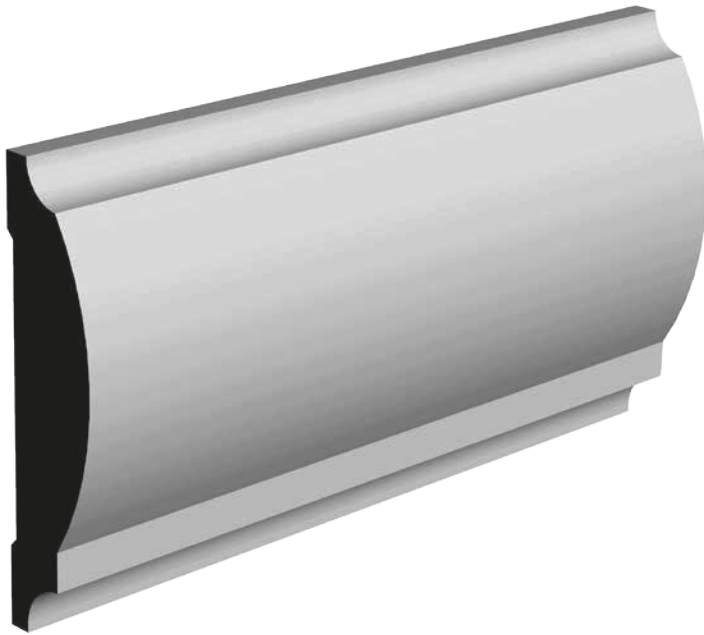

Chair Rail

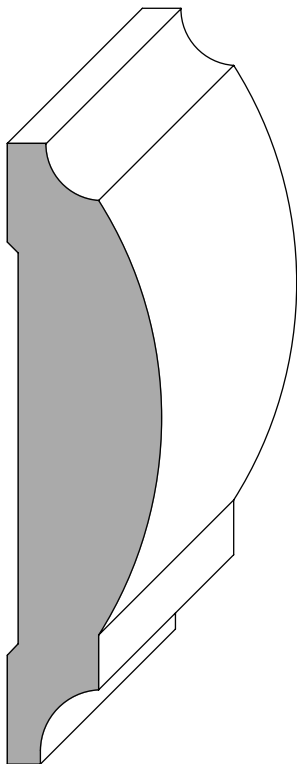

CHR360
13/16" x 3-1/4"

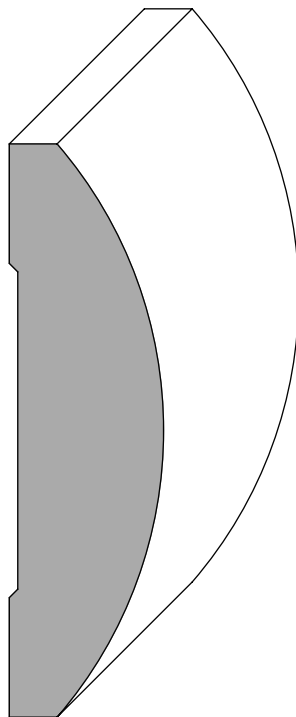

CHR361
13/16" x 3"

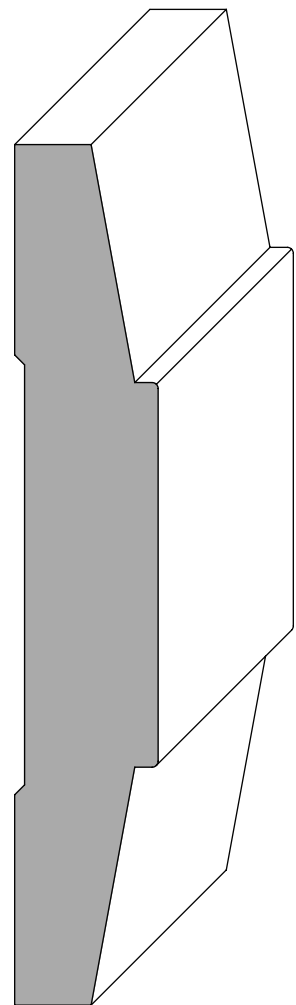

CHR362
3/4" x 4-1/2"

Chair Rail

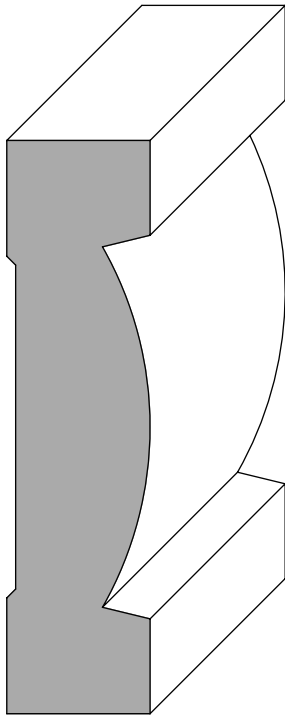

CHR366
3/4" x 3"

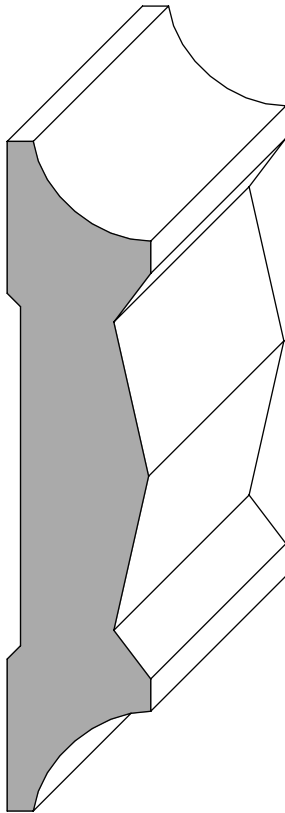

CHR367
3/4" x 3-1/2"

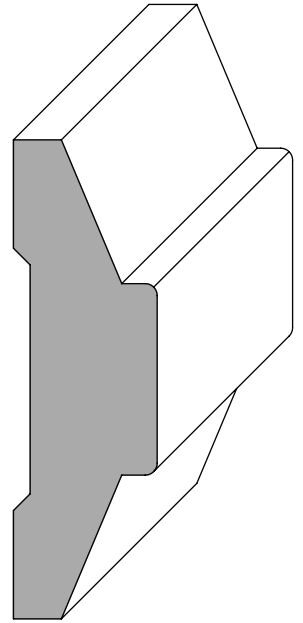

CHR368
3/4" x 2-1/2"

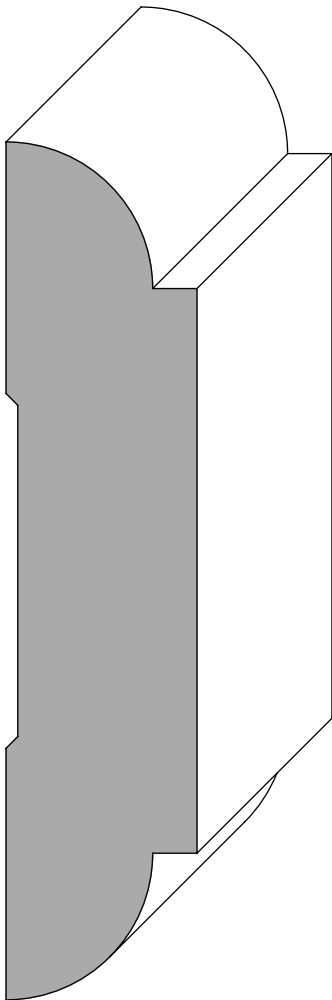

CHR363
1" x 4-1/2"

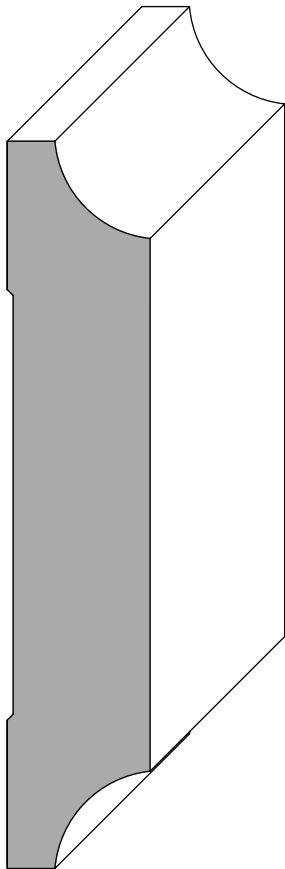

CHR364
3/4" x 3-13/16"

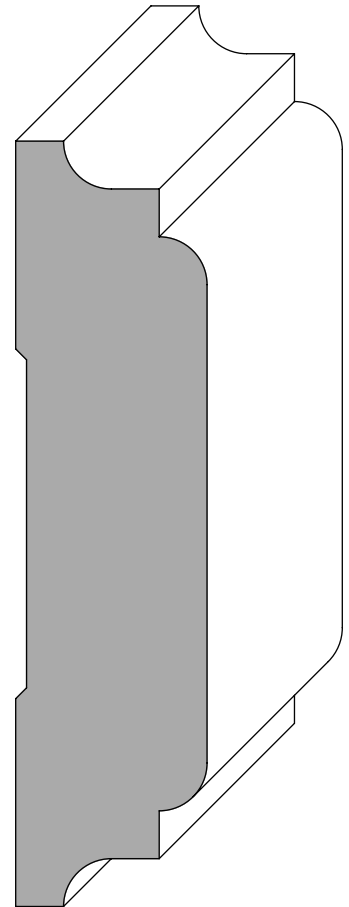

CHR365
1" x 4"

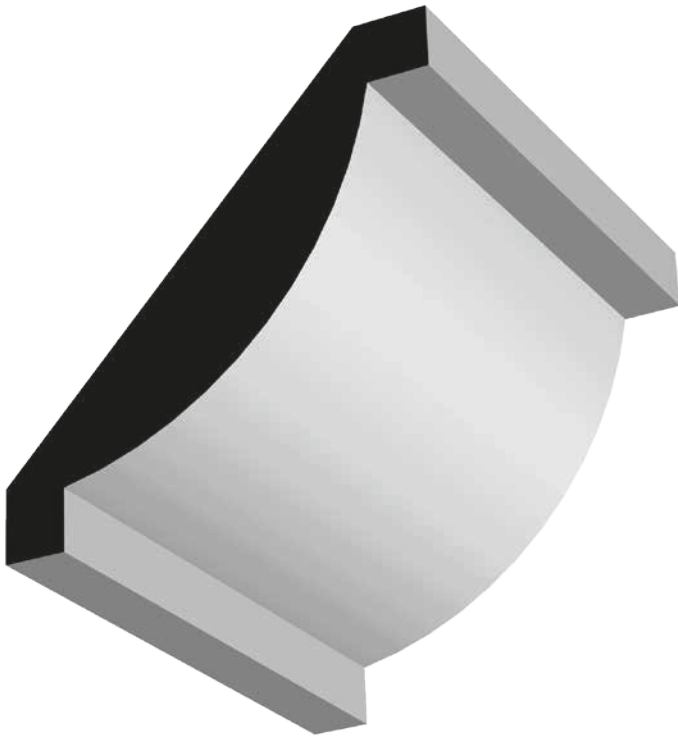

Crown

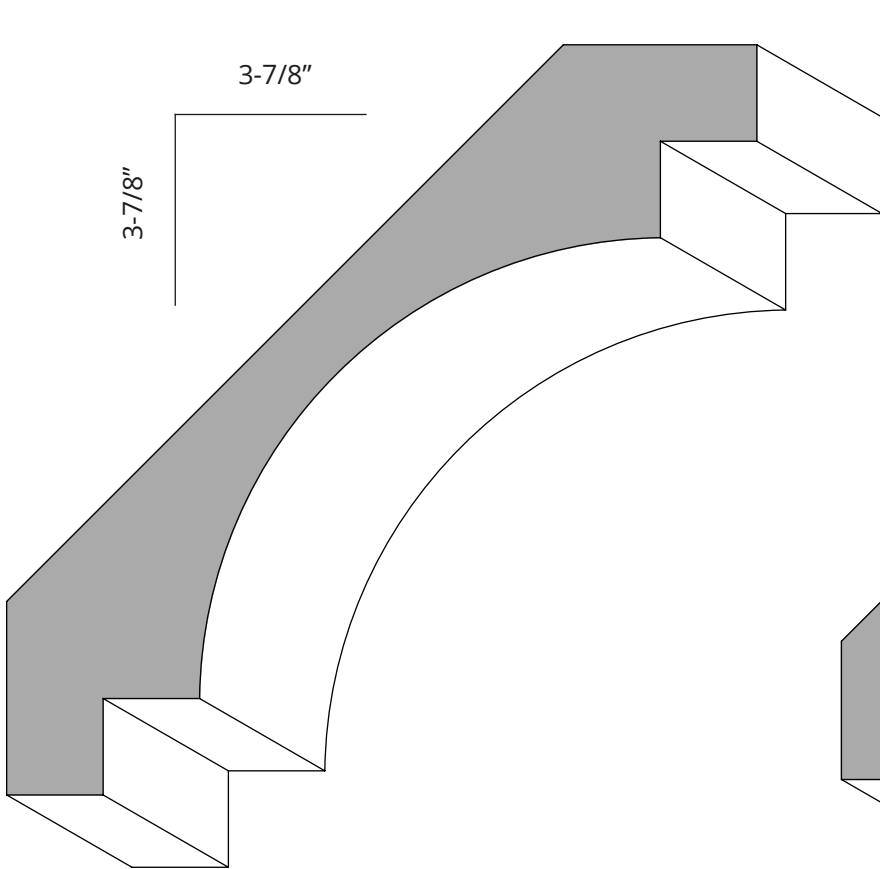

CR520
1-1/16" x 5-1/2"

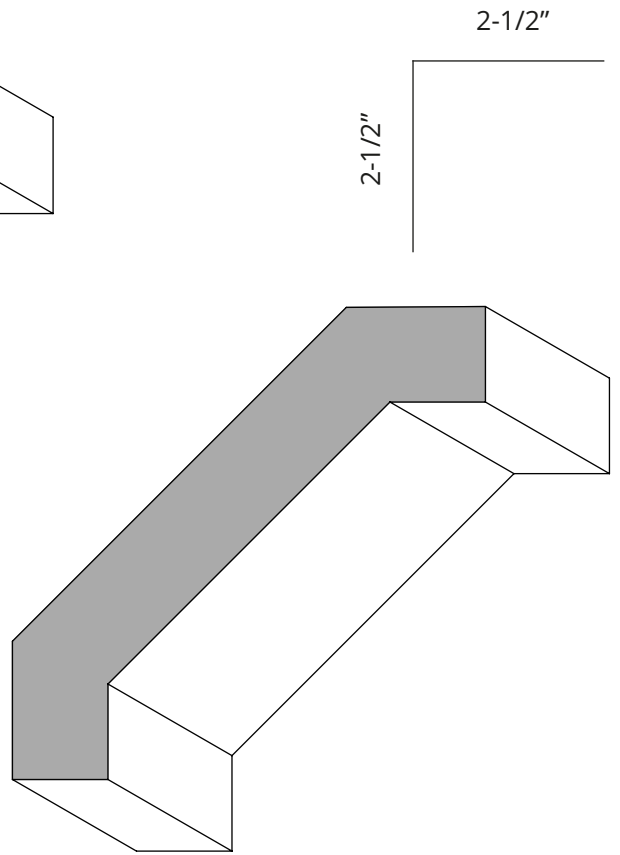

CR504
7/8" x 3-1/2"

Crown

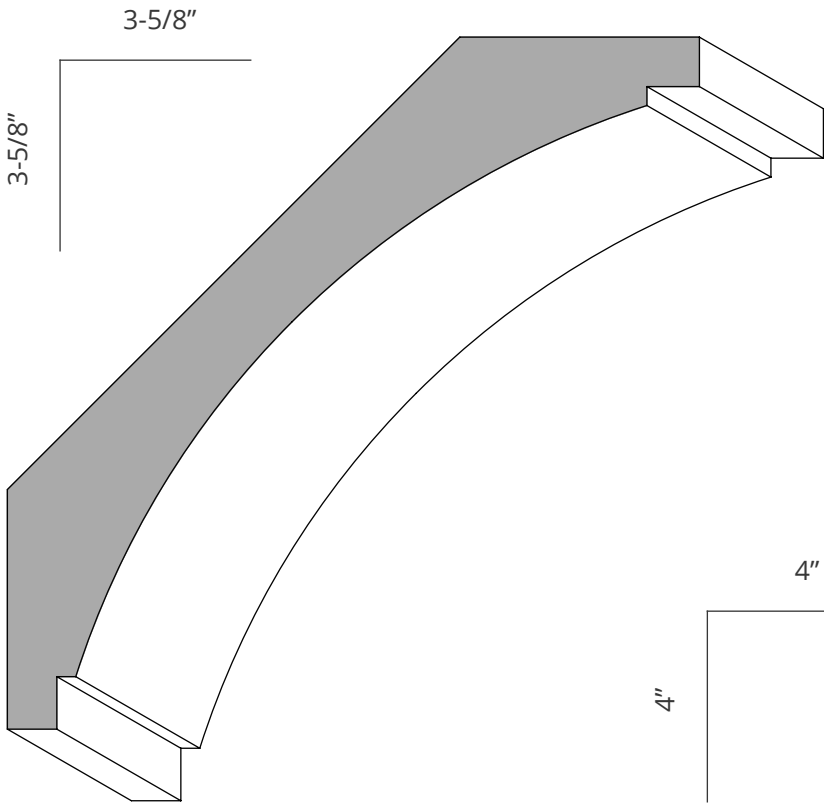

CR522
1-1/16" x 5-1/8"

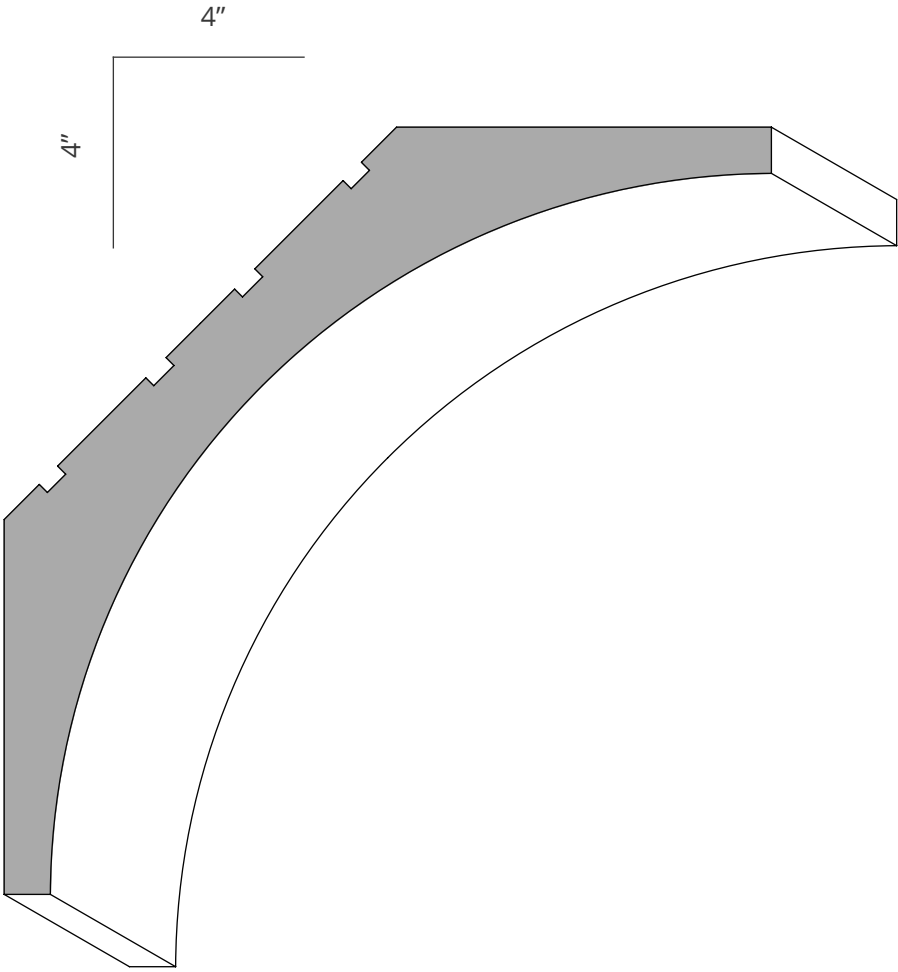

CR523
1-9/16" x 5-5/8"

Crown

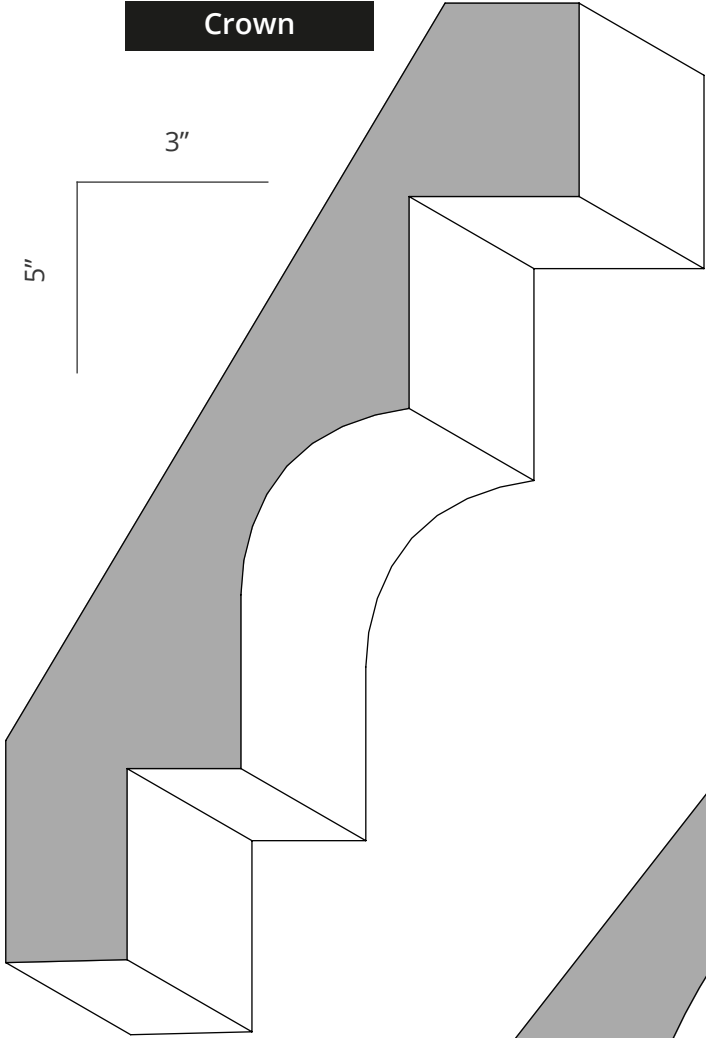

CR526
1-1/8" x 5-13/16"

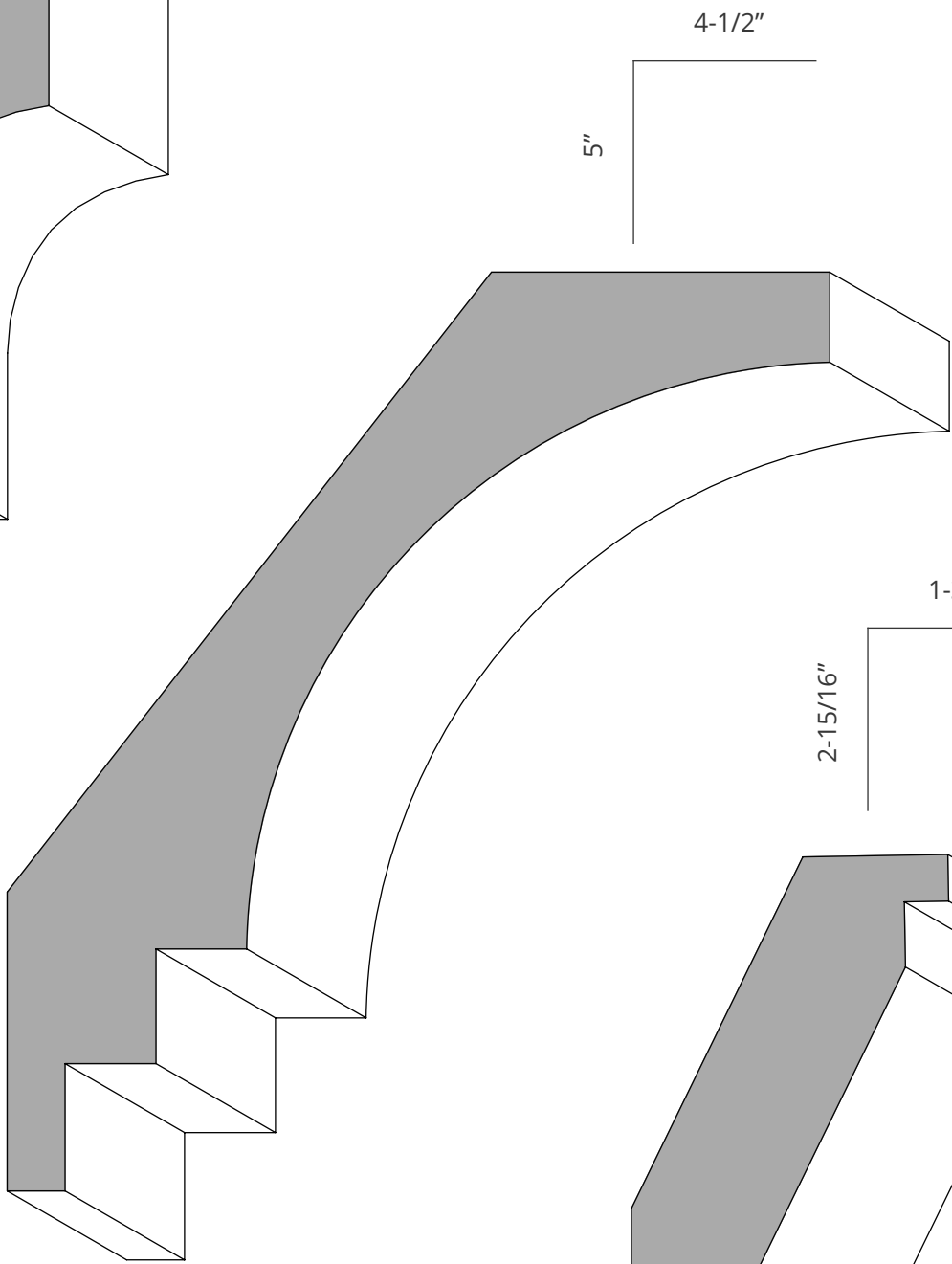

CR527
1-3/4" x 6-11/16"

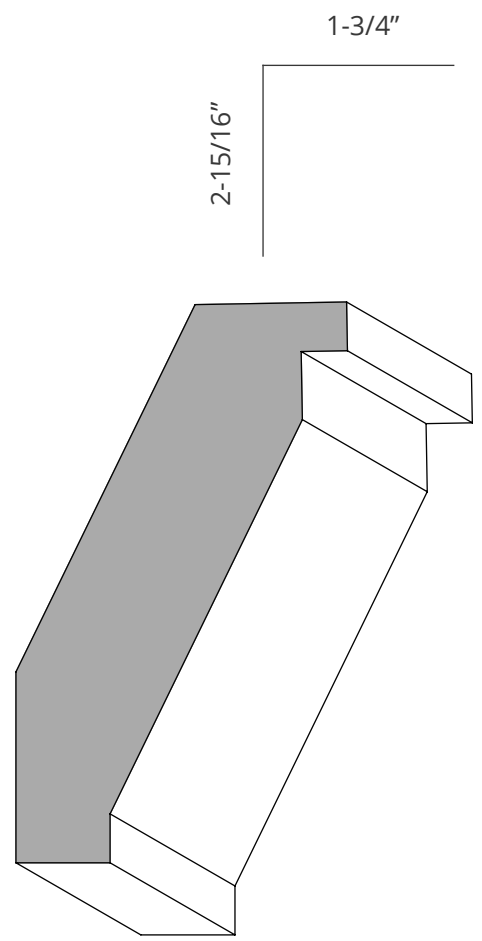

CR525
7/8" x 3-3/8"

Crown

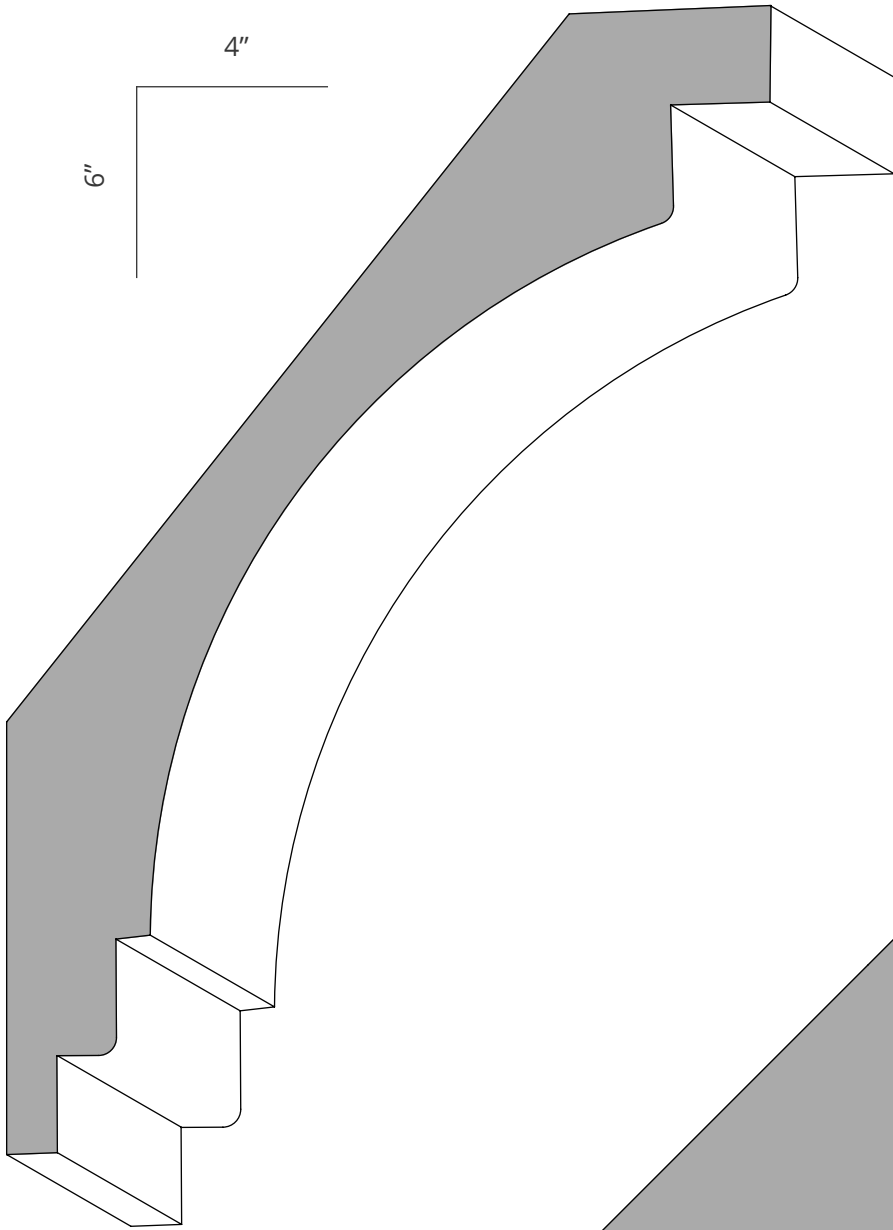

CR528
1-5/8" x 7-3/16"

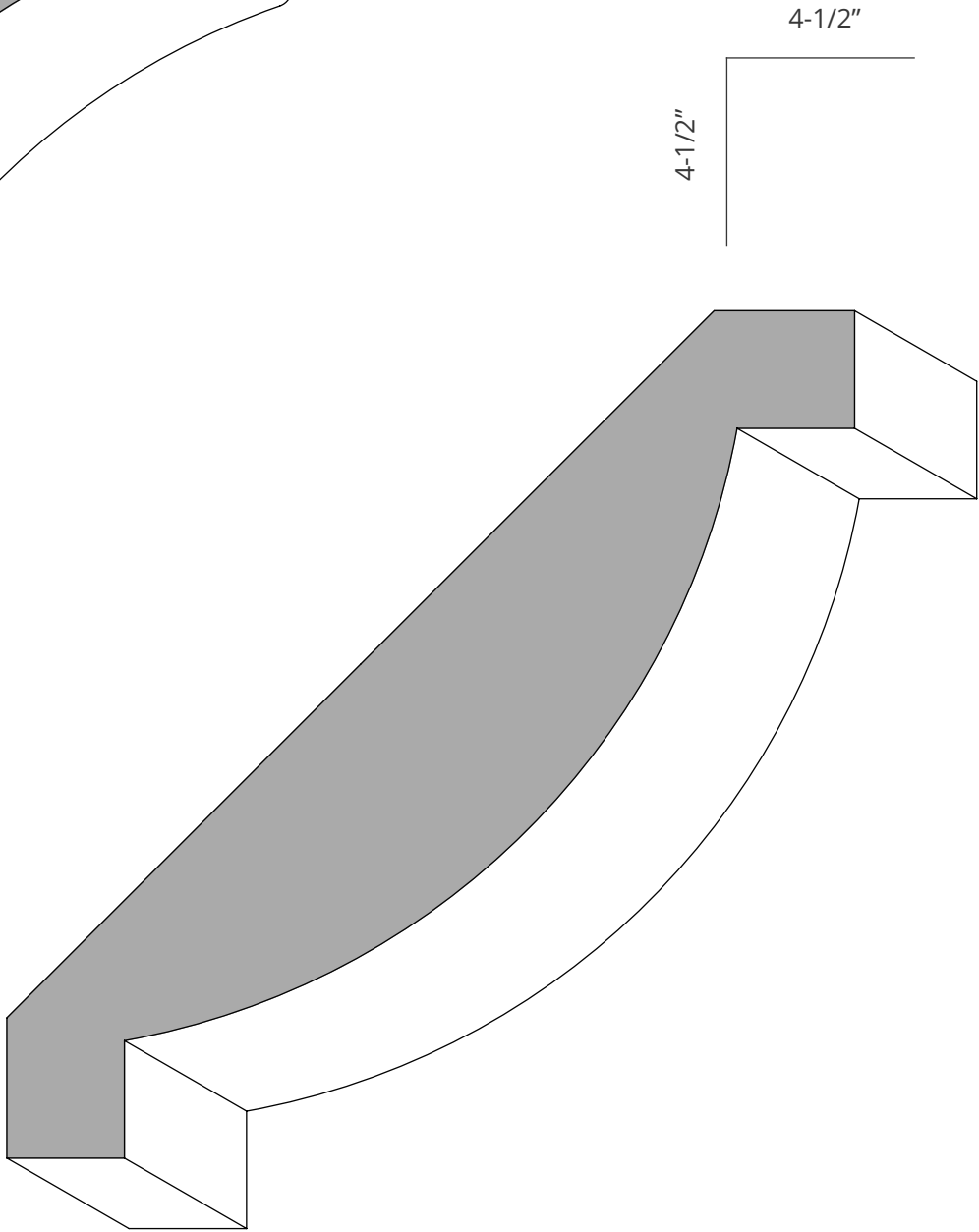

CR529
1-1/4" x 6-3/8"

Crown

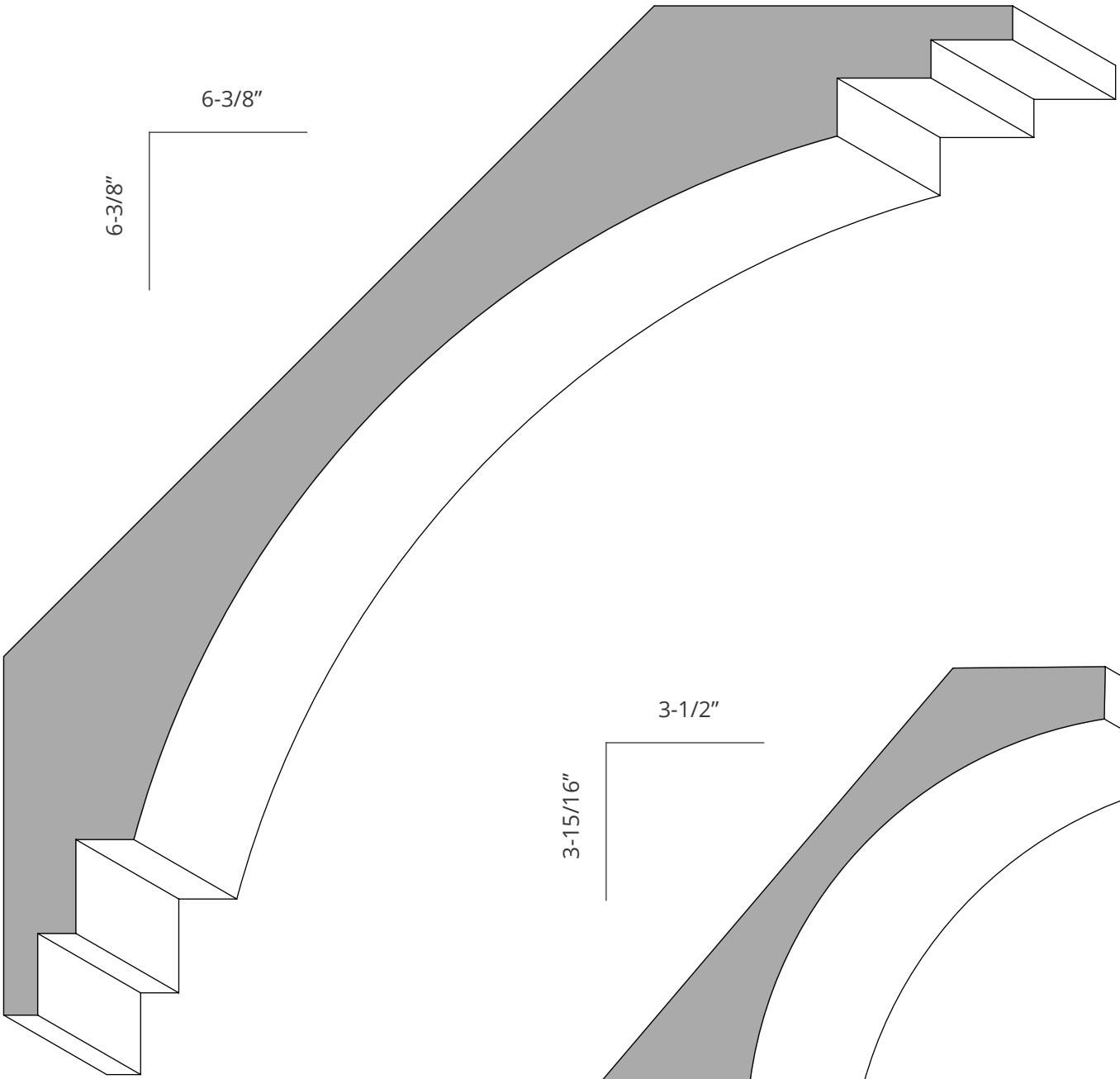

CR531
1-3/4" x 9"

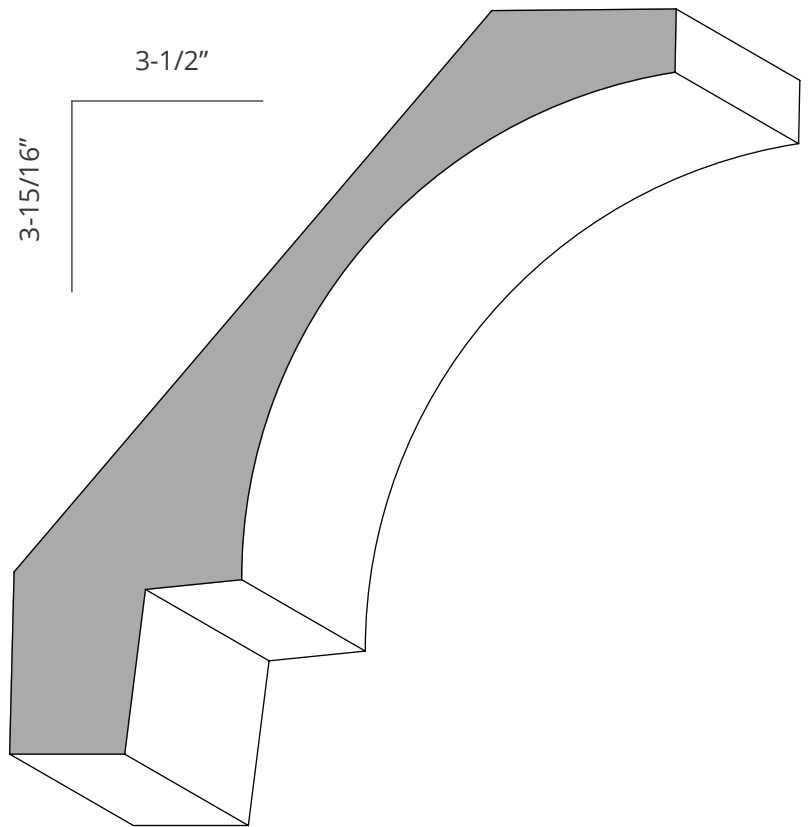

CR530
1-1/16" x 5-1/4"

Crown

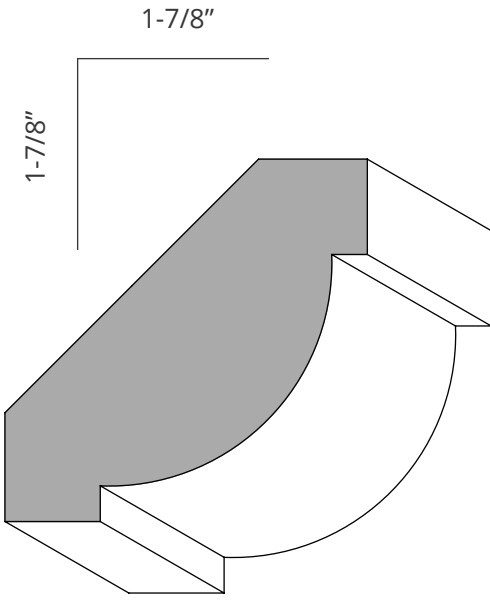

CR532
1" x 2-11/16"

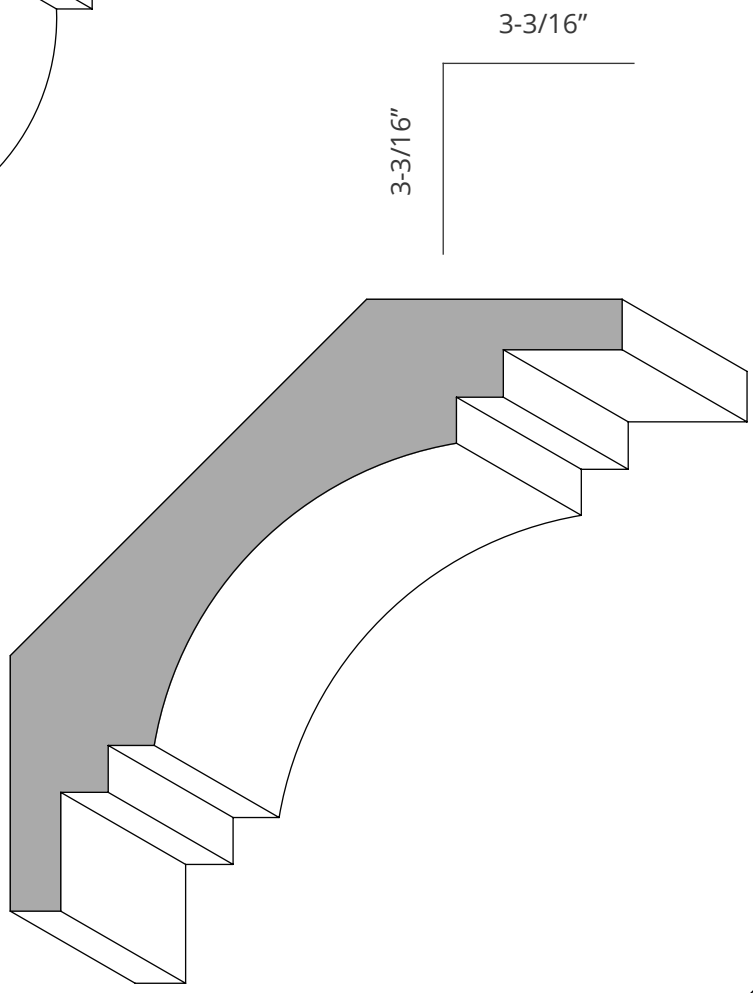

CR533
1-1/8" x 4-1/2"

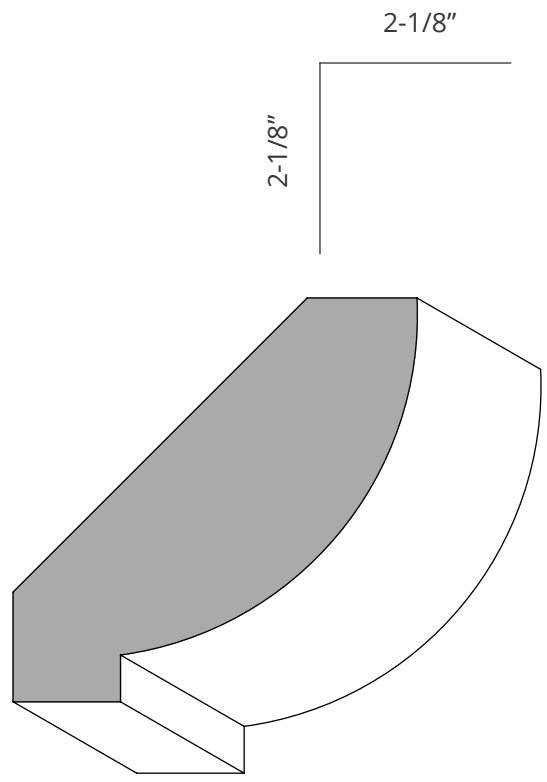

CR534
1" x 3"

Crown

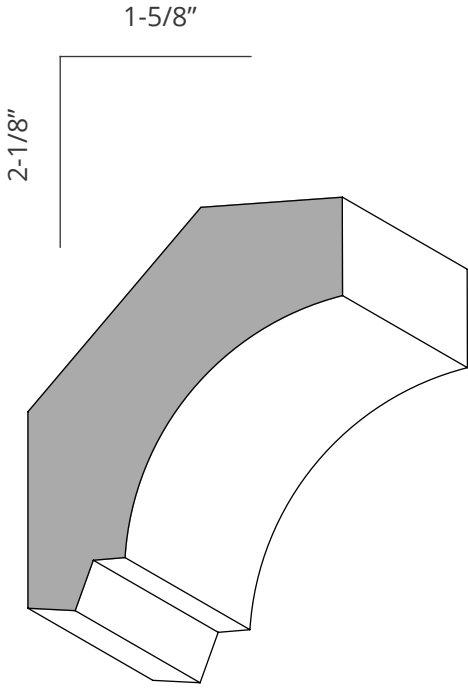

CR535
7/8" x 2-11/16"

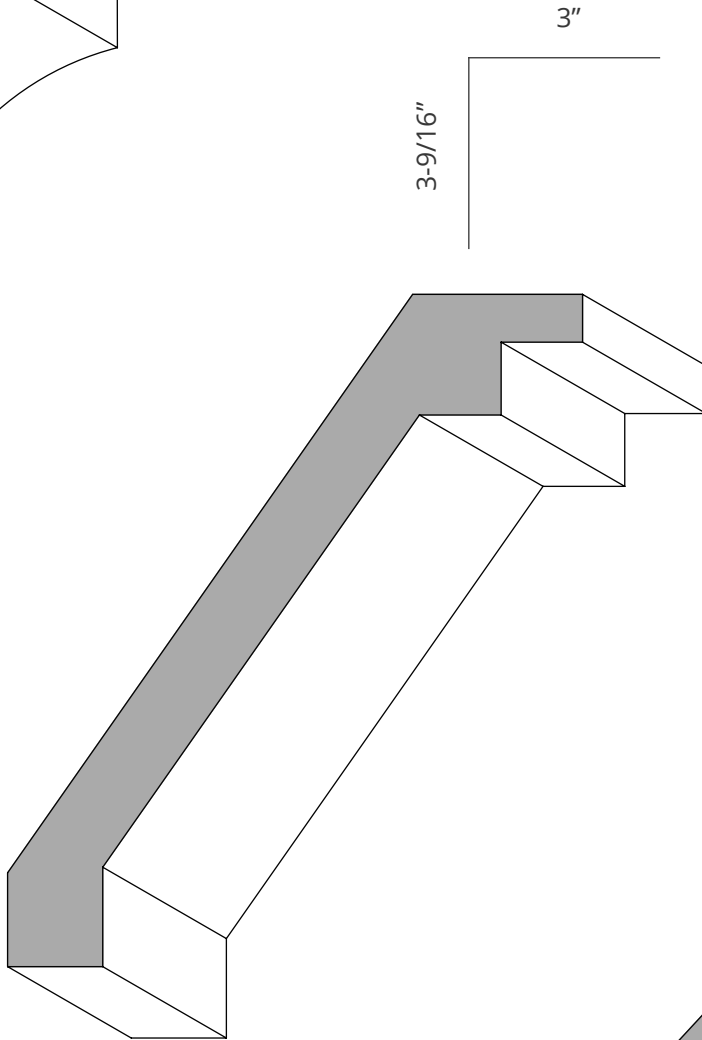

CR537©
7/8" x 4-5/8"

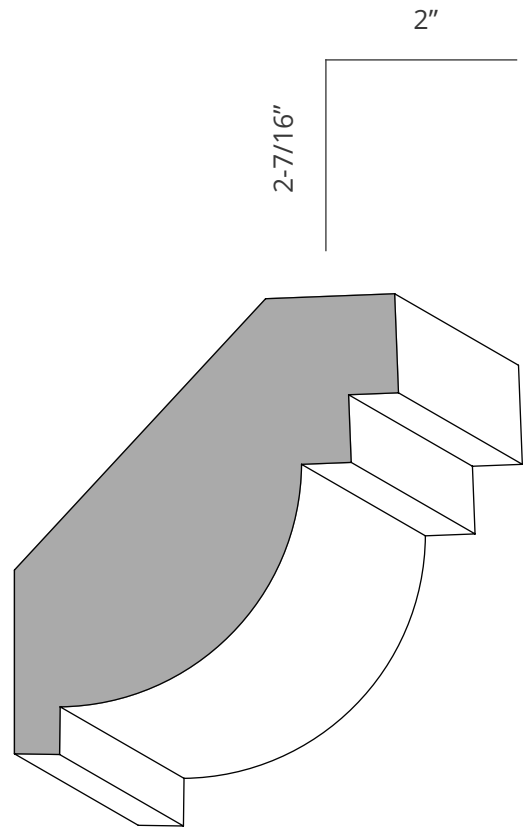

CR536
1-1/16" x 3-1/8"

Crown

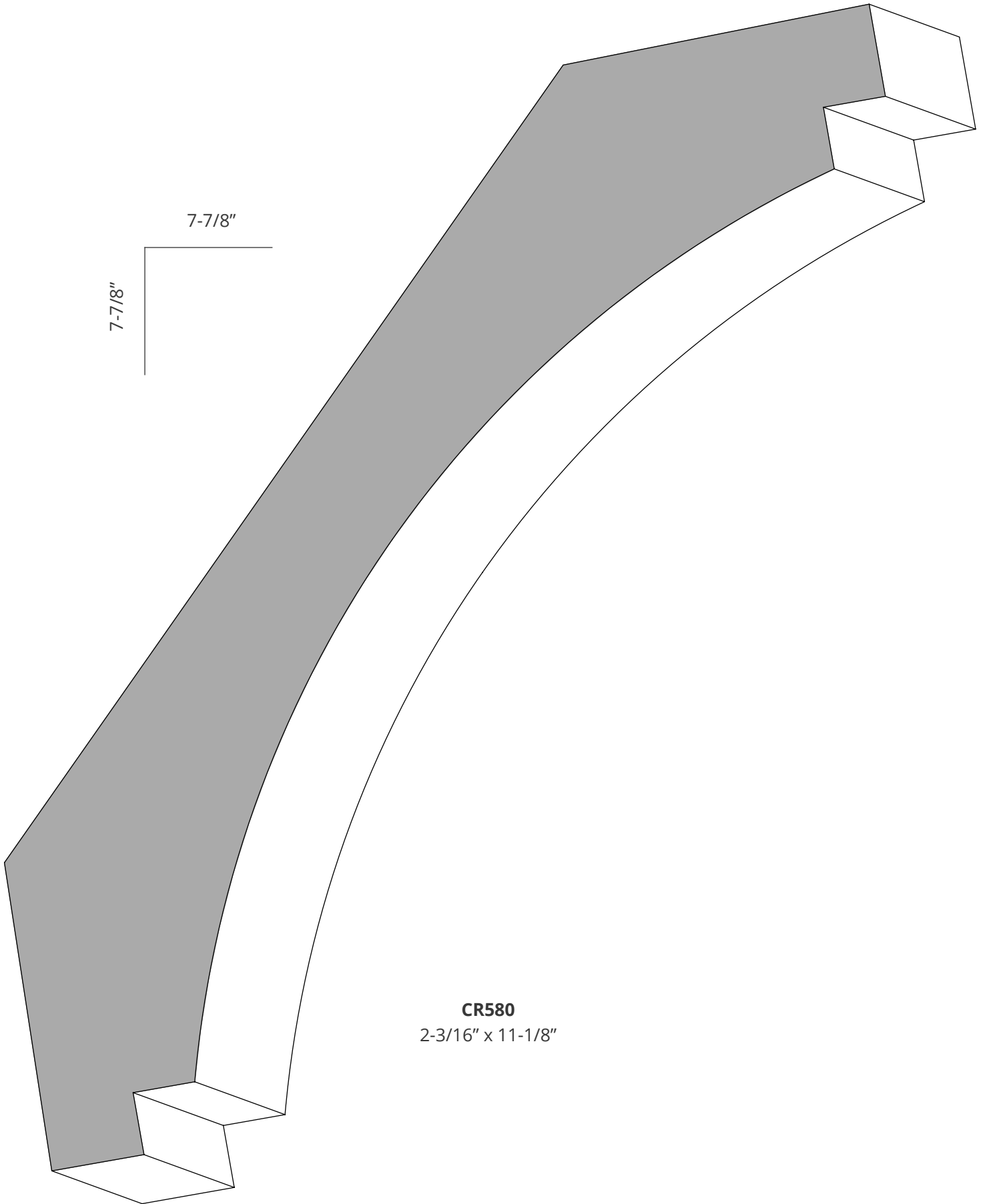

CR580
2-3/16" x 11-1/8"

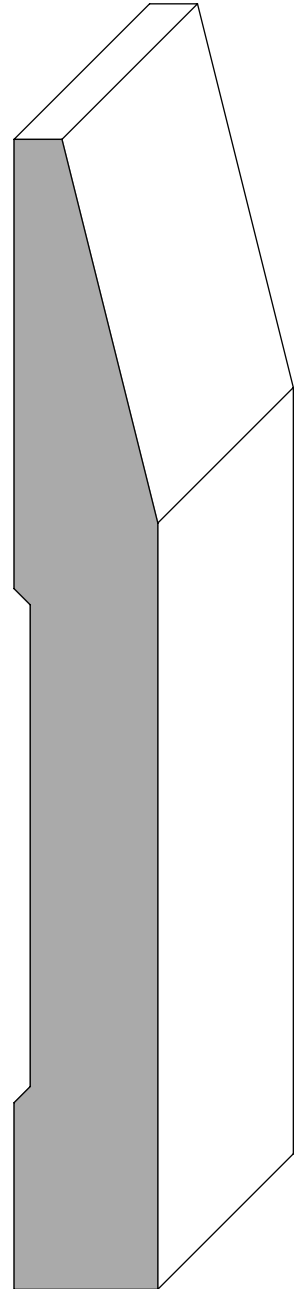

Base

B521
3/4" x 6"

Base

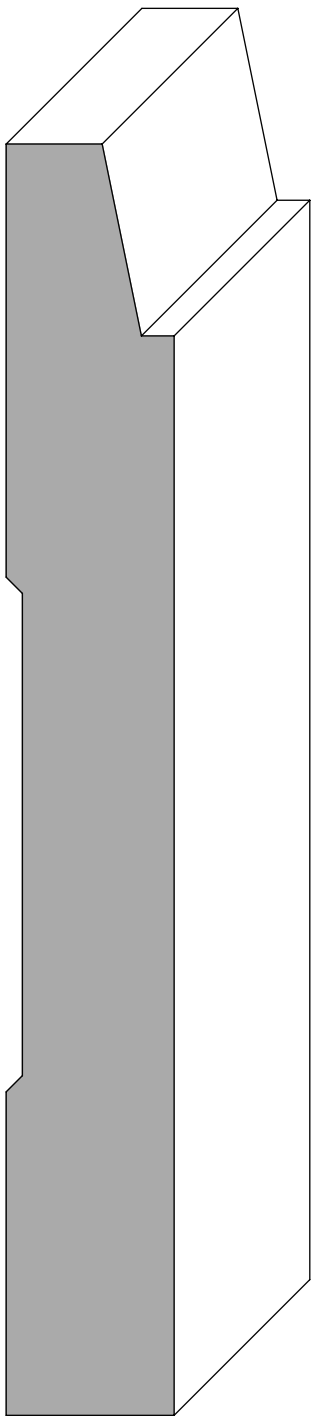

B524
7/8" x 6-5/8"

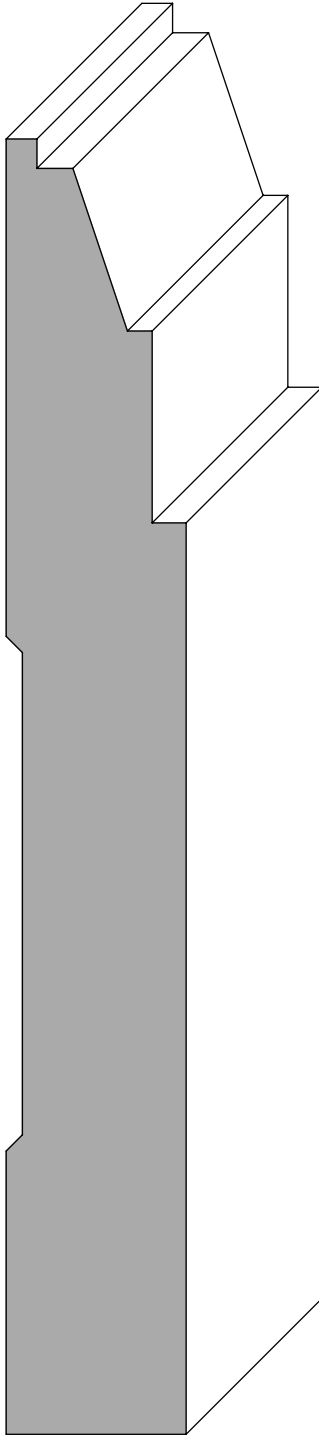

B526
15/16" x 6-3/4"

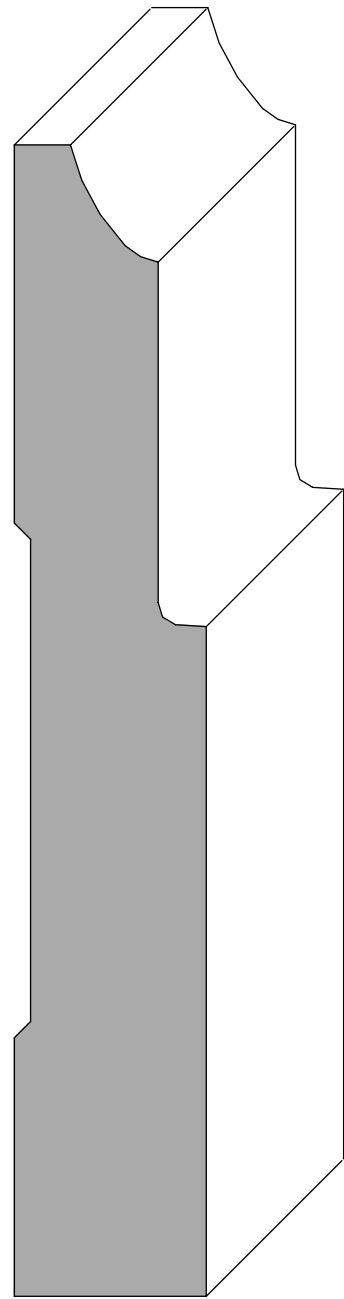

B535
1" x 6"

Base

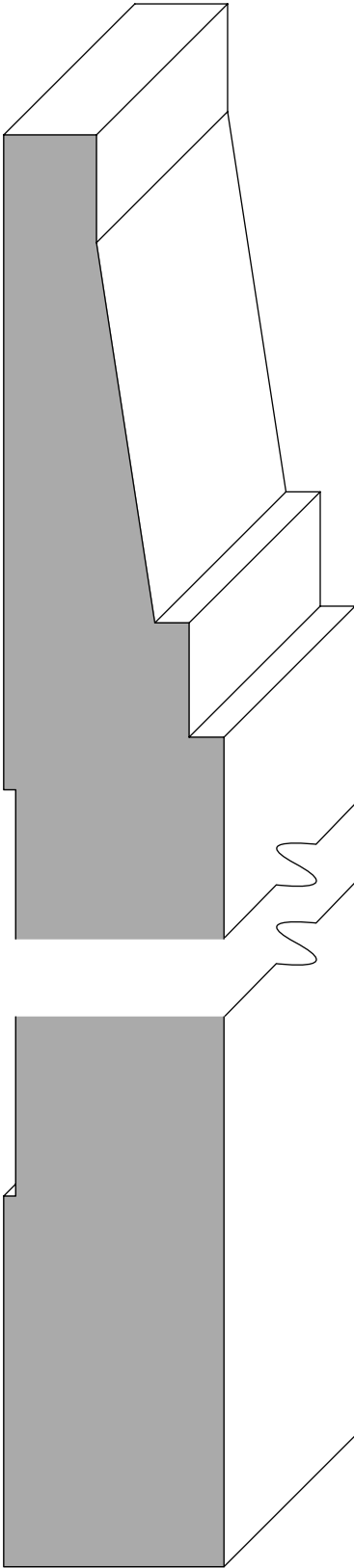

B536
1-3/16" x 10-1/4"

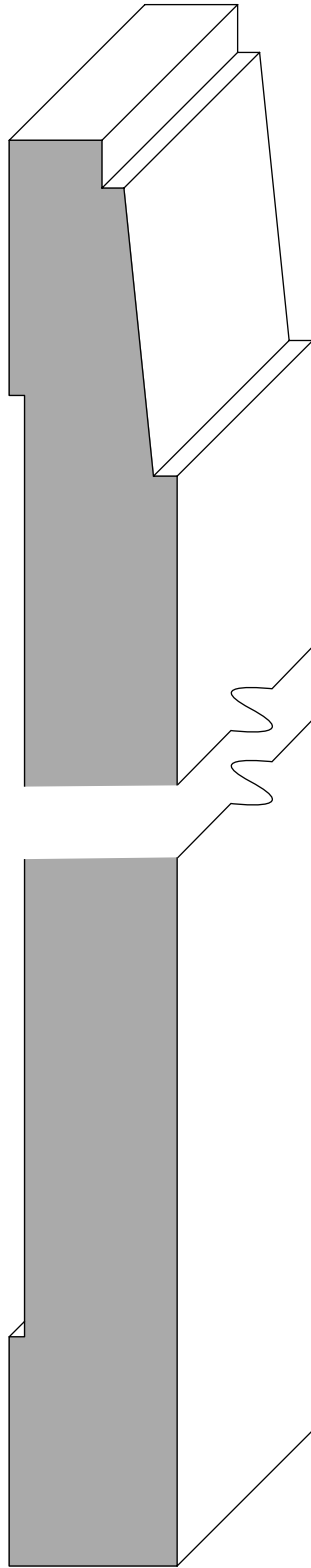

B537
7/8" x 9"

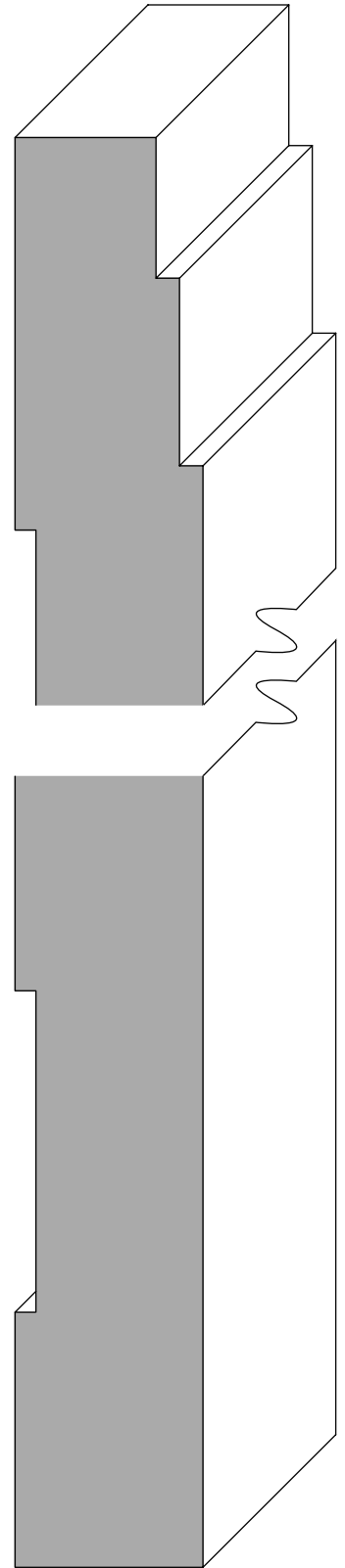

B538
1" x 9-1/2"

Base

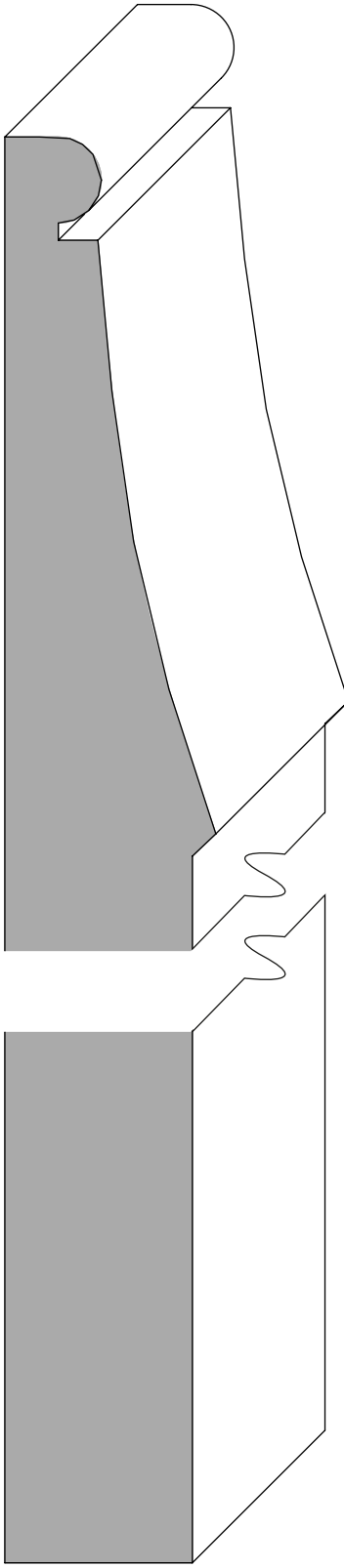

B539©
1-1/8" x 8-3/4"

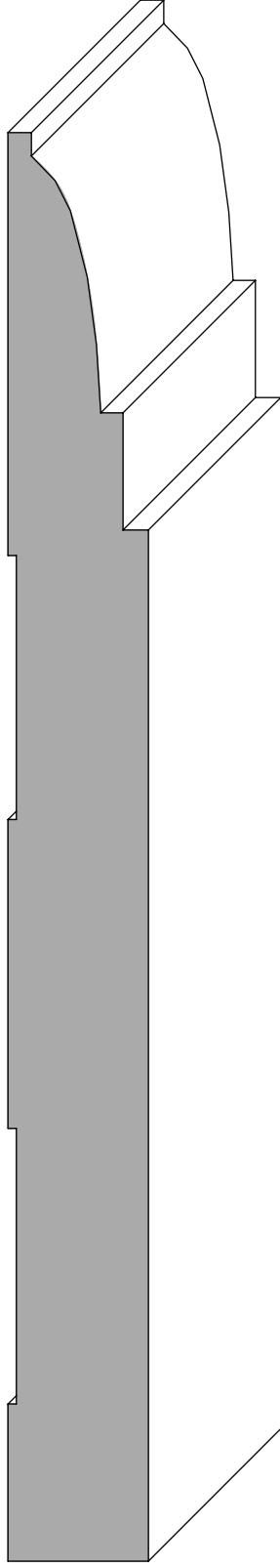

B540
3/4" x 7-5/8"

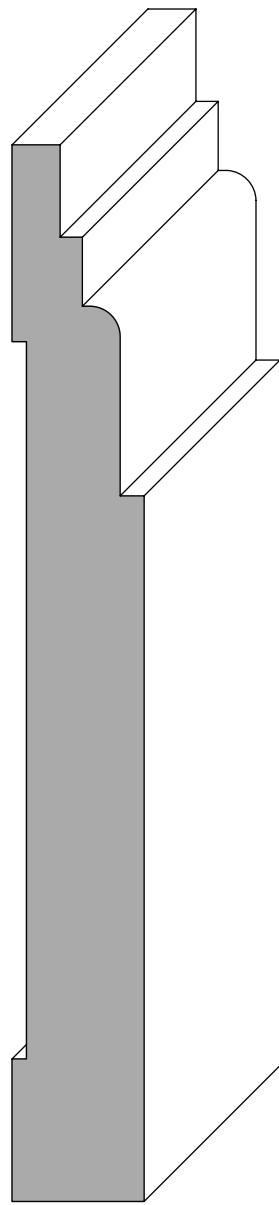

B541©
11/16" x 5-1/2"

Base

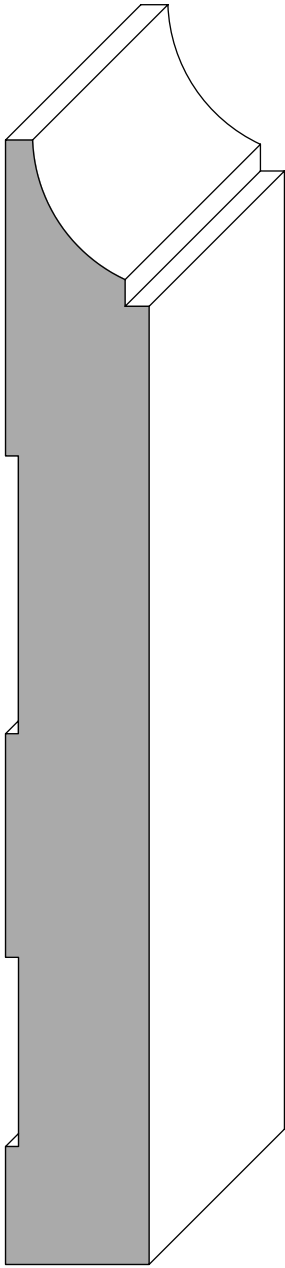

B542
3/4" x 5-7/8"

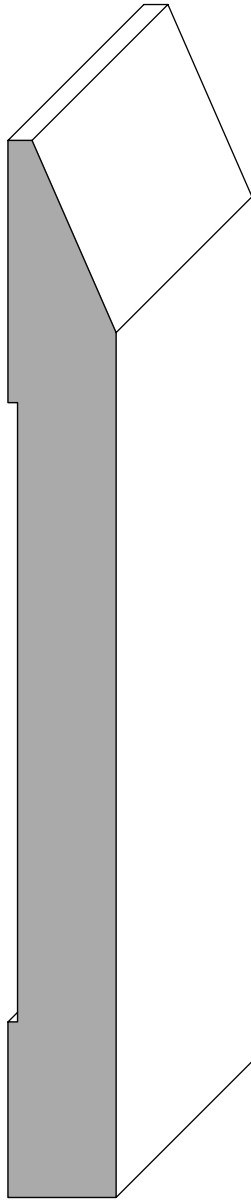

B543
9/16" x 5-1/2"

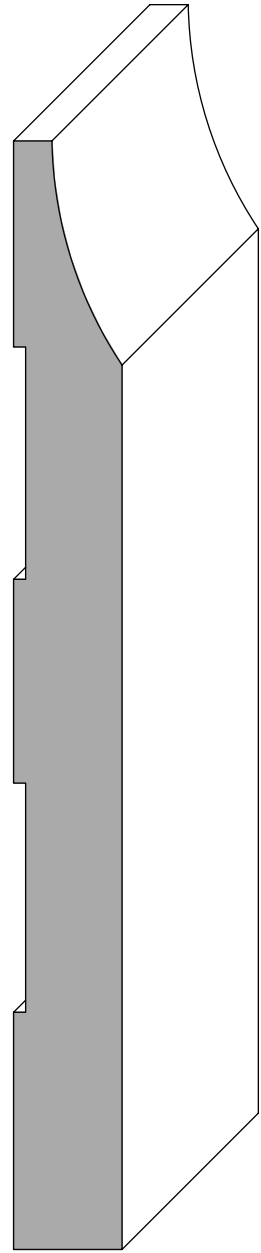

B544
9/16" x 5-3/4"

Base

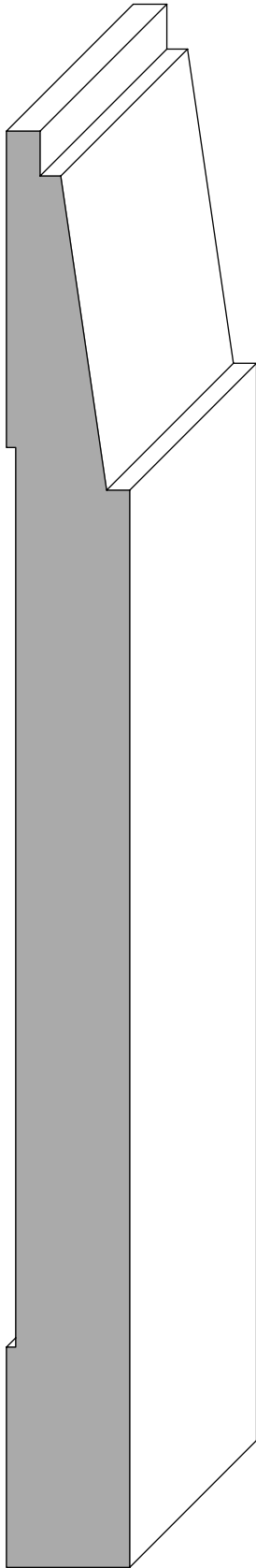

B545
11/16" x 8"

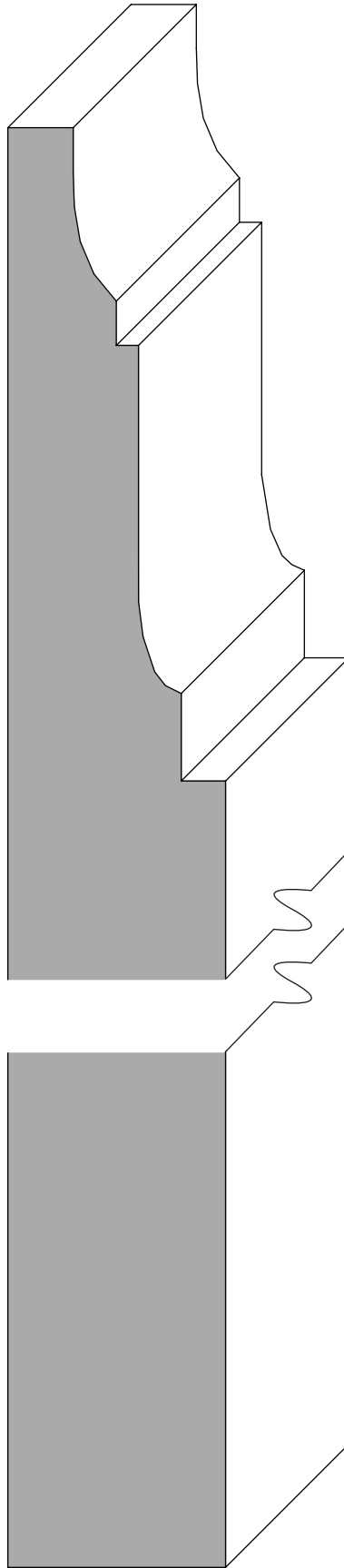

B546
1-1/4" x 9"

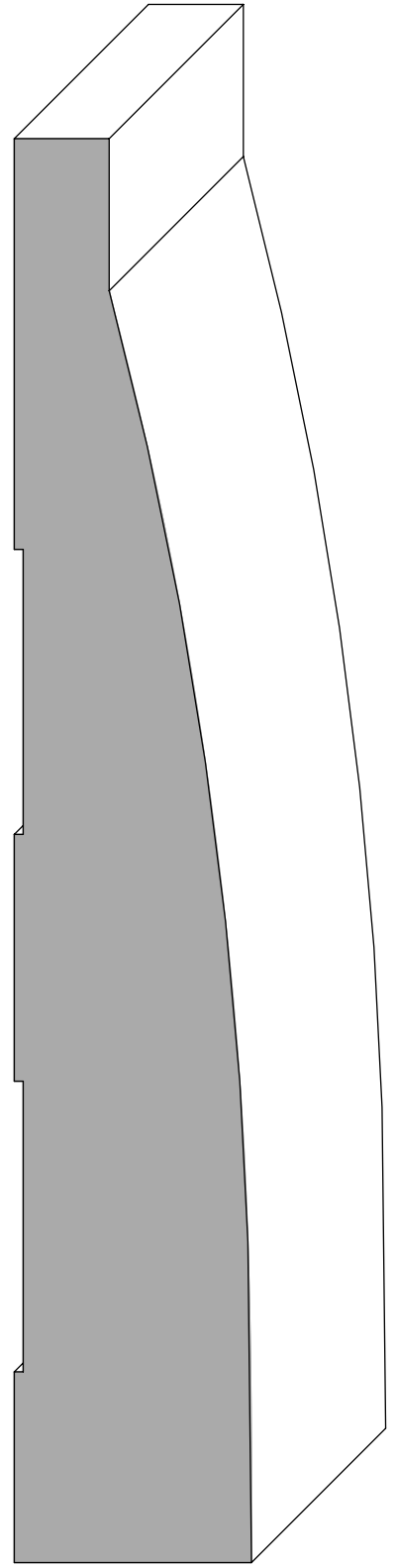

B547
1-1/4" x 7-1/2"

Base

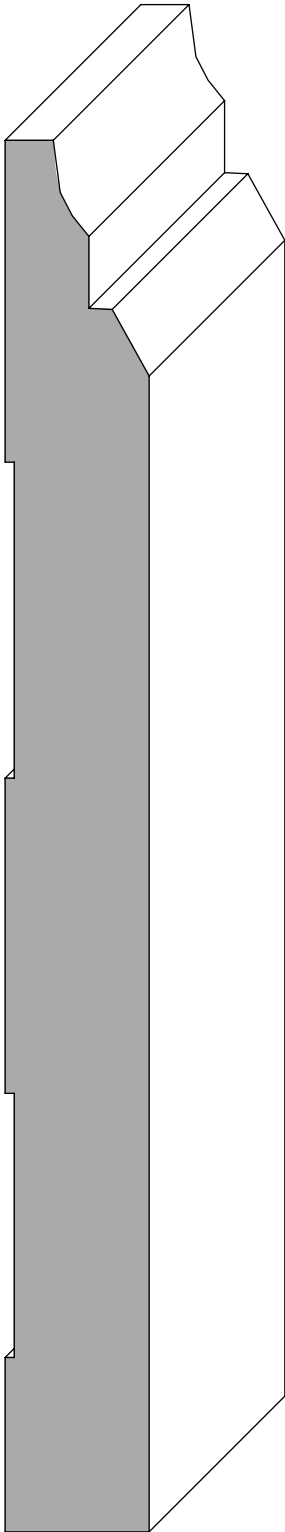

B548
3/4" x 7-1/4"

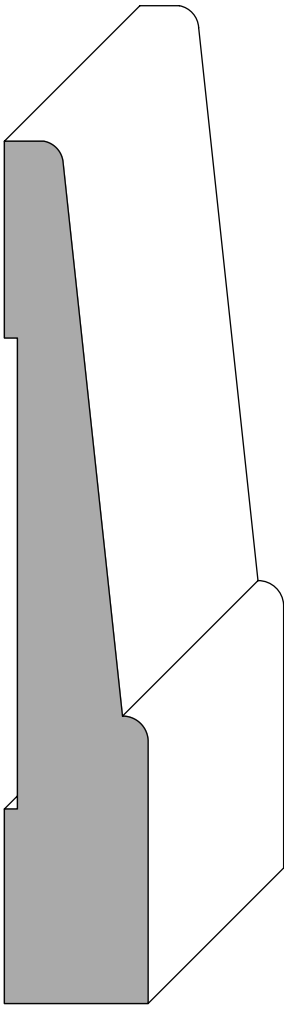

B549
3/4" x 4-1/2"

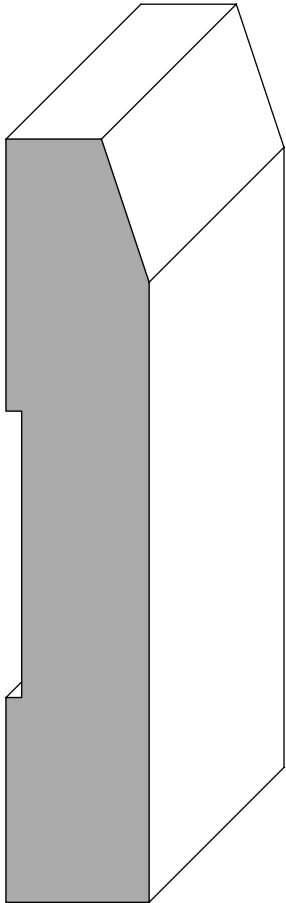

B550
3/4" x 4"

Base

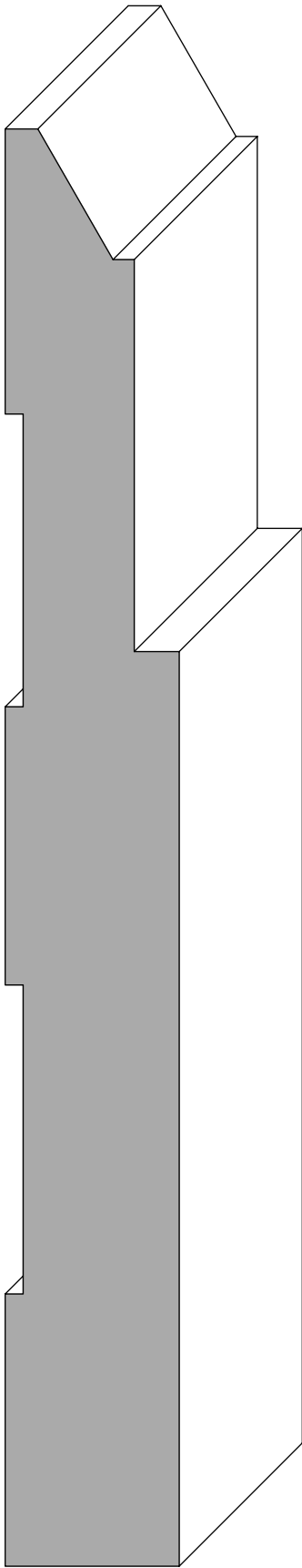

B552
1" x 8-1/4"

800-523-4231

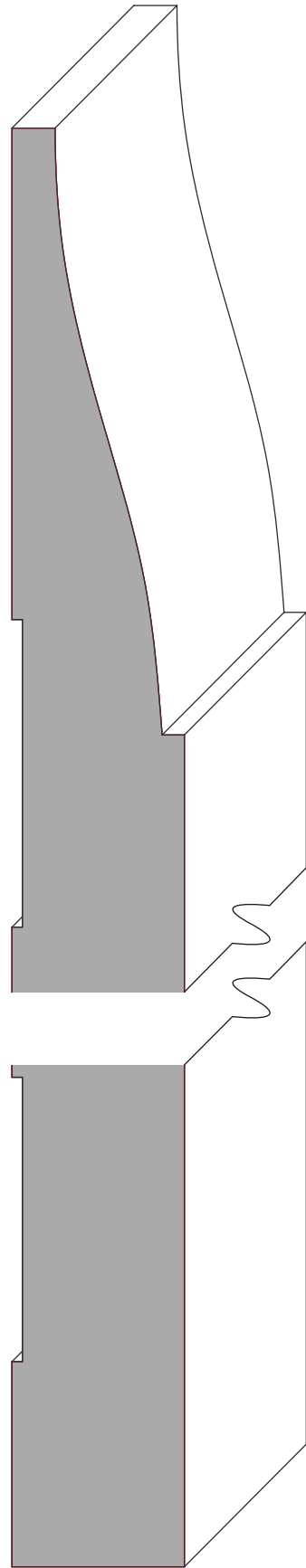

B551
1" x 9-1/2"

sales@alanmcilvain.com

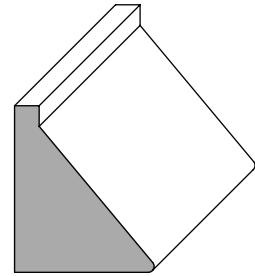
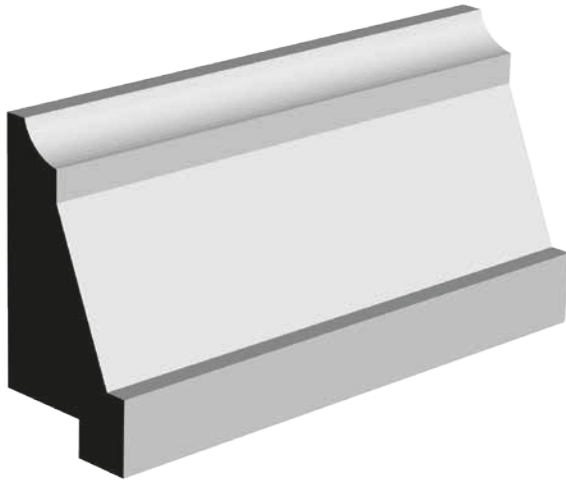

Panel Moulding

PA53
3/4" x 7/8"

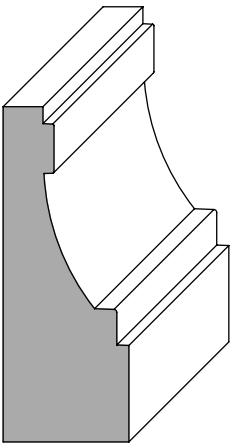

PA50
11/16" x 1-3/4"

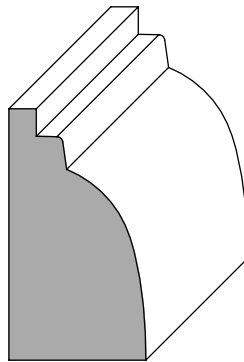

PA54
11/16" x 1-5/16"

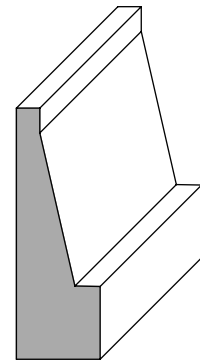

PA51
7/16" x 1-5/16"

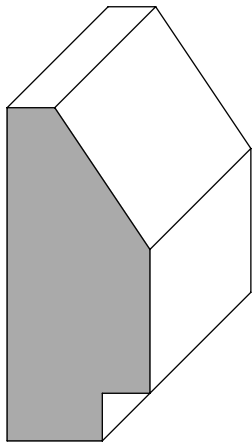

PA55
3/4" x 1-3/4"

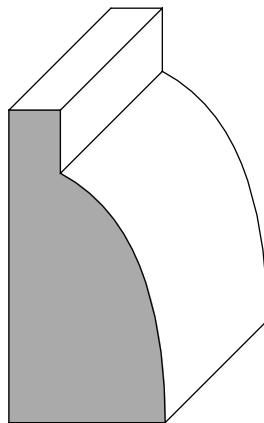

PA57
13/16" x 1-5/8"

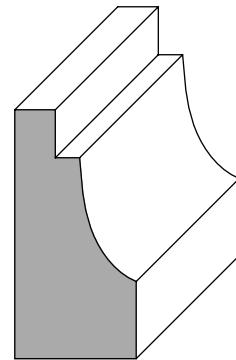

PA52
5/8" x 1-5/16"

Panel Moulding

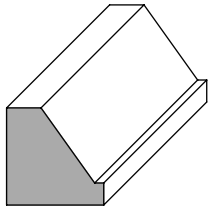

PA56
1/2" x 1/2"

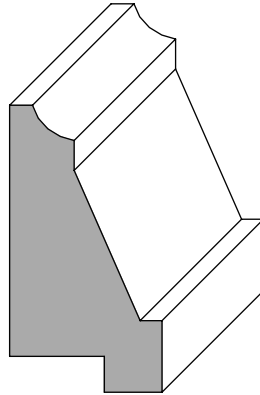

PA60
13/16" x 1-1/2"

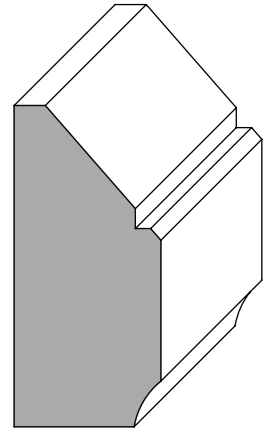

PA59
3/4" x 1-11/16"

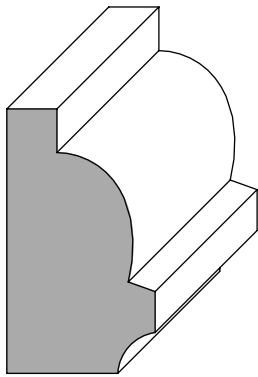

PA58
3/4" x 1-3/8"

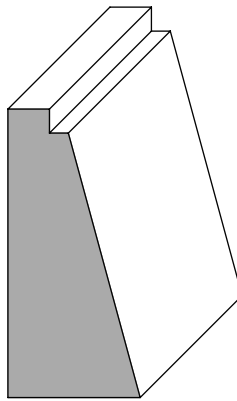

PA64
1/16" x 1-1/2"

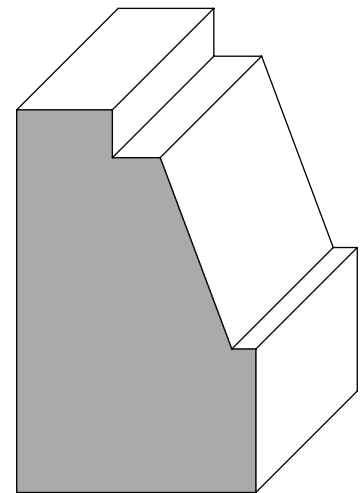

PA62
1-1/4" x 2"

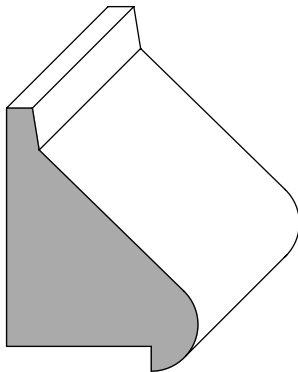

PA61
1" x 1-3/8"

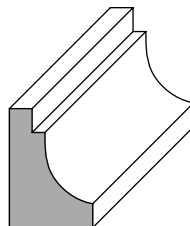

PA63
7/16" x 5/8"

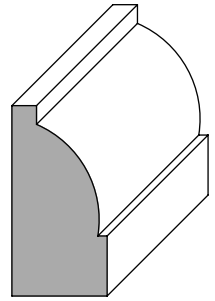
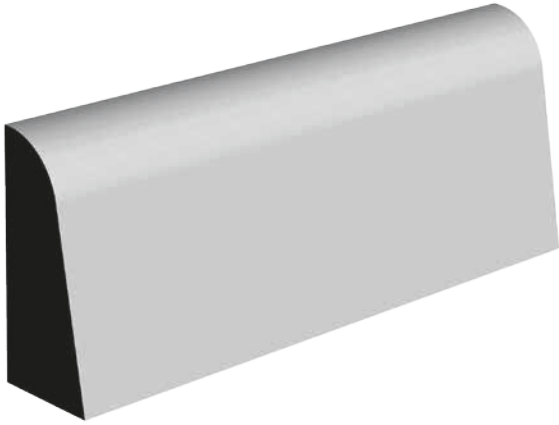

S24©
1/2" x 1"

Shoe Moulding

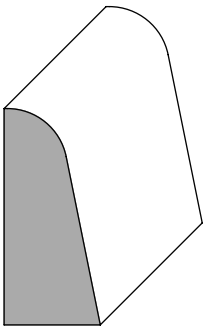

S27
1/2" x 1-1/8"

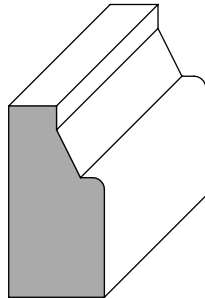

S23
1/2" x 1"

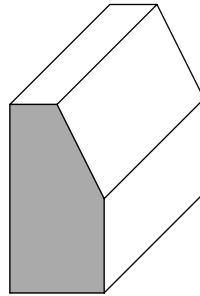

S28
1/2" x 1"

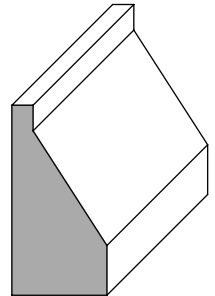

S26©
1/2" x 1"

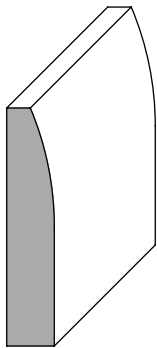

S20
1/4" x 1-1/4"

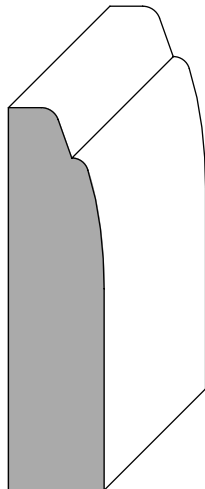

S21
1/2" x 2"

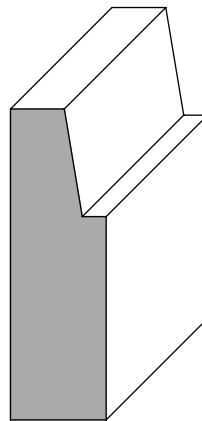

S25
1/2" x 1-5/8"

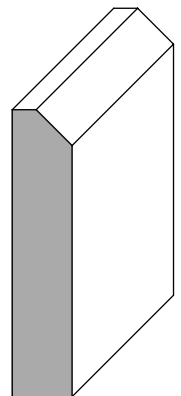

S22
5/16" x 1-1/2"

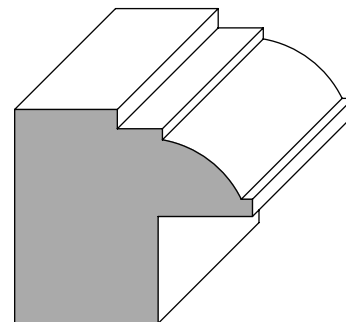
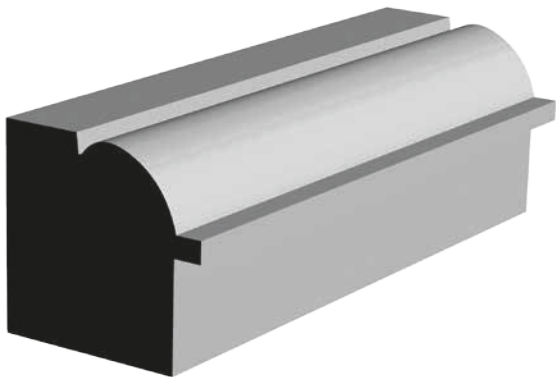

Backband

BB621
1-1/8" x 1-1/4"

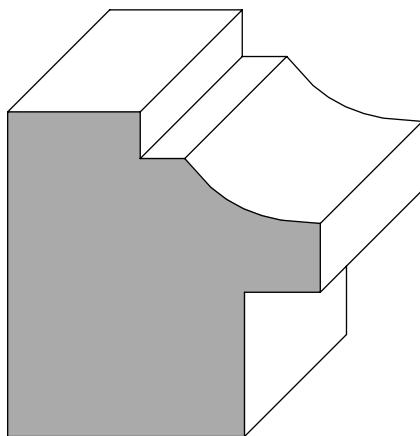

BB624
1-5/8" x 1-11/16"

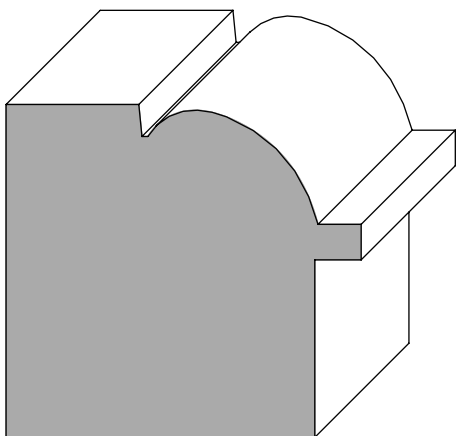

BB622
1-3/4" x 1-7/8"

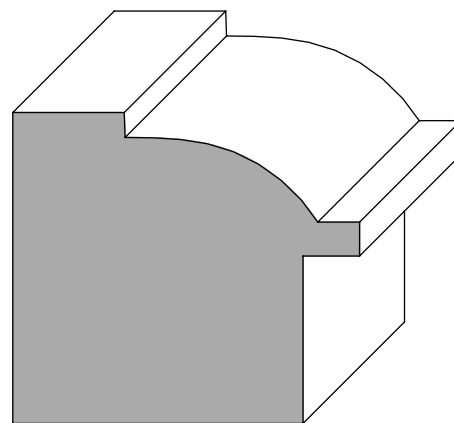

BB628
1-5/8" x 1-13/16"

Backband

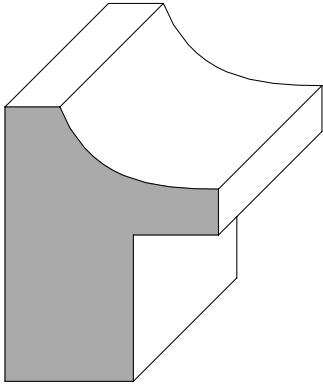

BB623
1-1/8" x 1-7/16"

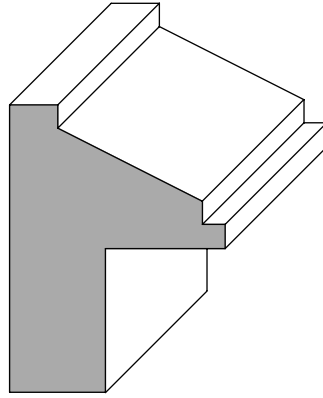

BB630
1-1/8" x 1-1/2"

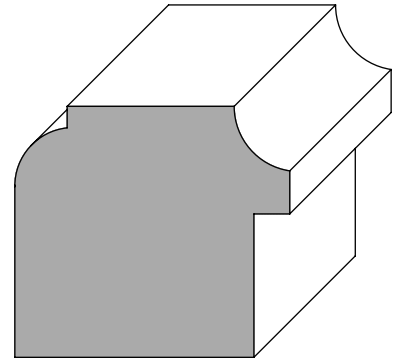

BB625
1-5/16" x 1-7/16"

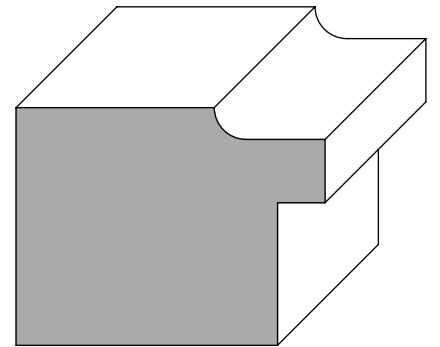

BB629
1-1/4" x 1-5/8"

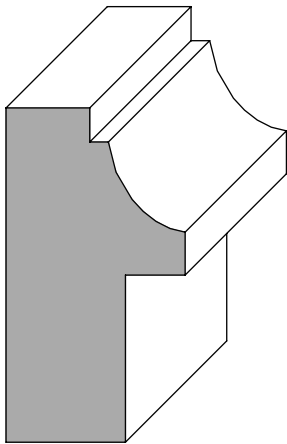

BB620
15/16" x 1-3/4"

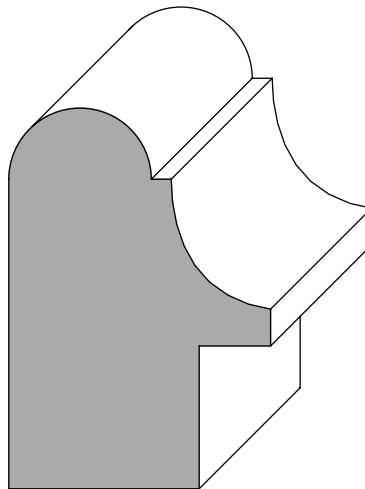

BB627
1-3/8" x 2"

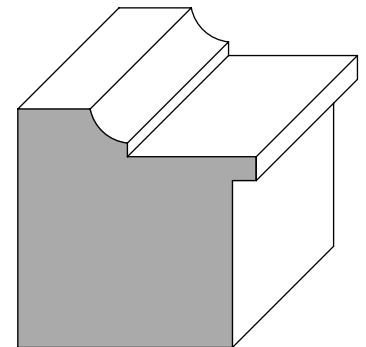

BB626
1-1/4" x 1-1/4"



Shiplap

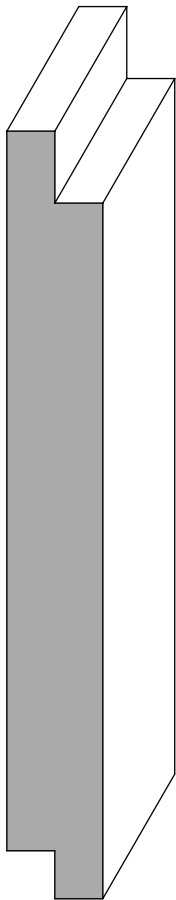

SL40
1/2" x 4"

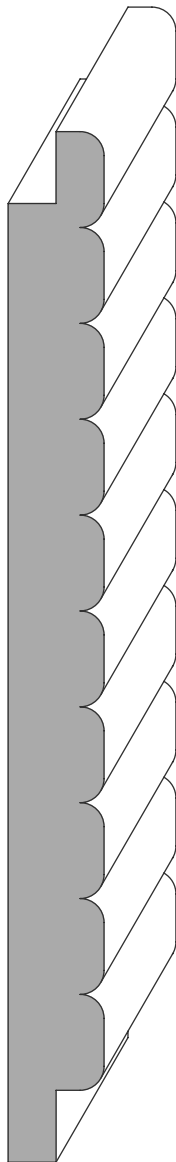

SL51
1/2" x 5-3/8"

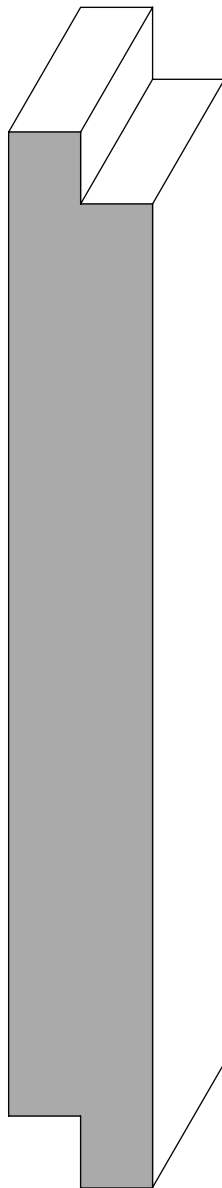

SL56
3/4" x 5-1/2"

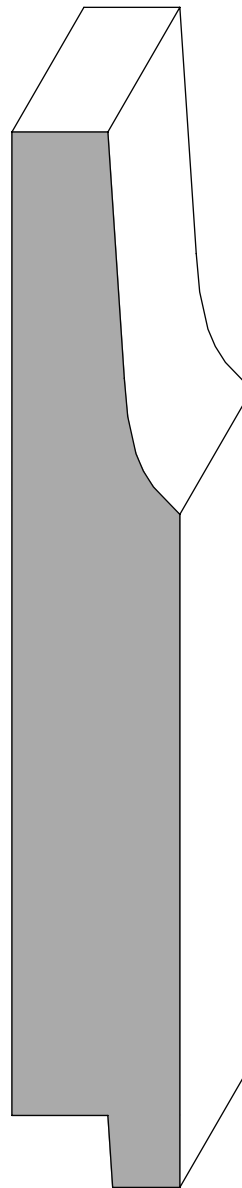

SL57
7/8" x 5-1/2"

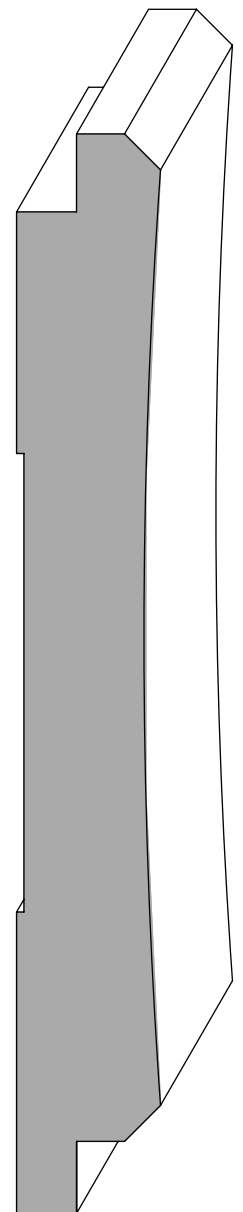

SL55
3/4" x 5-5/8"



Tongue & Groove

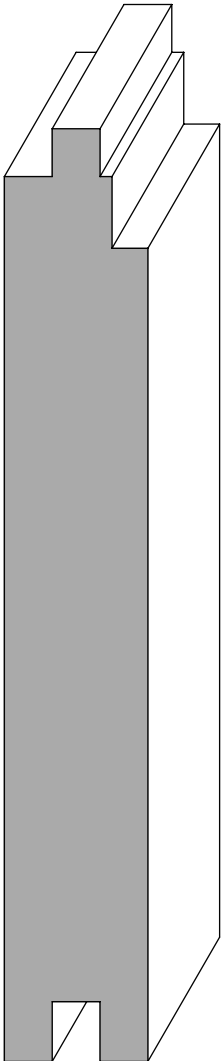

TG41
3/4" x 4-7/8"

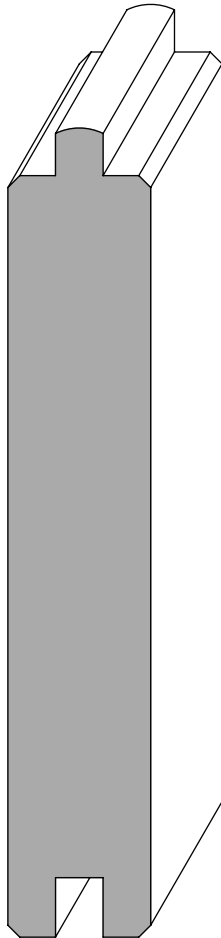

TG43
3/4" x 4-1/4"

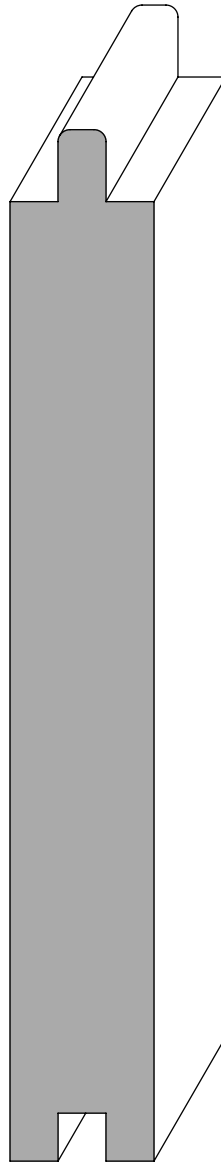

TG42
3/4" x 5-3/8"

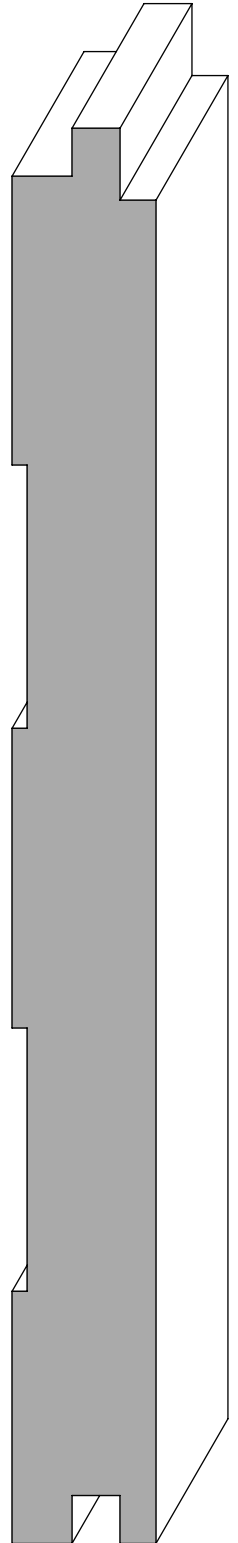

TG71
3/4" x 7-3/8"

Index

Backbands

BB620	-	34
BB621	-	33
BB622	-	33
BB623	-	34
BB624	-	33
BB625	-	34
BB626	-	34
BB627	-	34
BB628	-	33
BB629	-	34
BB630	-	34

Bases

B521	-	22
B524	-	23
B526	-	23
B535	-	23
B536	-	24
B537	-	24
B538	-	24
B539	-	25
B540	-	25
B541	-	25
B542	-	26
B543	-	26
B544	-	26
B545	-	27
B546	-	27
B547	-	27
B548	-	28
B549	-	28
B550	-	28
B551	-	29
B552	-	29

Casings

C501	-	6
C505	-	7
C506	-	7
C510	-	6
C511	-	6
C514	-	7
C515	-	8

C526	-	8
C532	-	8
C535	-	9
C536	-	9
C542	-	9
C544	-	10
C555	-	10
C556	-	10
C557	-	11
C560	-	11
C561	-	10
C562	-	11
C563	-	10
C564	-	11
C565	-	11
C566	-	11

Chair Rails

CHR360	-	12
CHR361	-	12
CHR362	-	12
CHR363	-	13
CHR364	-	13
CHR365	-	13
CHR366	-	13
CHR367	-	13
CHR368	-	13

Crowns

CR504	-	14
CR520	-	14
CR522	-	15
CR523	-	15
CR525	-	16
CR526	-	16
CR527	-	16
CR528	-	17
CR529	-	17
CR530	-	18
CR531	-	18
CR532	-	19
CR533	-	19
CR534	-	19
CR535	-	20
CR536	-	20

CR537	-	20
CR580	-	21

Panel Mouldings

PA50	-	30
PA51	-	30
PA52	-	30
PA53	-	30
PA54	-	30
PA55	-	30
PA56	-	31
PA57	-	30
PA58	-	31
PA59	-	31
PA60	-	31
PA61	-	31
PA62	-	31
PA63	-	31
PA64	-	31

Shiplap Mouldings

SL40	-	35
SL51	-	35
SL55	-	35
SL56	-	35
SL57	-	35

Shoe Mouldings

S20	-	32
S21	-	32
S22	-	32
S23	-	32
S24	-	32
S25	-	32
S26	-	32
S27	-	32
S28	-	32

Tongue & Groove Mouldings

TG41	-	36
TG42	-	36
TG43	-	36
TG71	-	36

In-Stock Species



Ash



Basswood



Birch



Cherry



Qtrd. Cherry



Cypress



Hickory



White Hard Maple



Qtrd. Hard Maple



Soft Maple



Red Oak



Rift Red Oak



White Oak



Rift White Oak



Qtrd. White Oak



Rustic White Oak



Poplar



White Pine

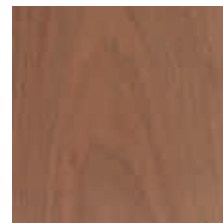

Walnut



Qtrd. Walnut

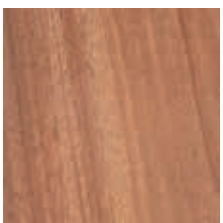

African Mahogany

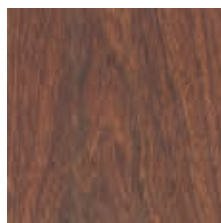

Ipe



Jatoba



Sapele



Spanish Cedar

Millwork Services

Custom Moulding

With over 35,000 knives in stock and the ability to custom manufacture virtually any profile, Alan McIlvain is your one-stop shop for high-end solid wood mouldings. Five high-speed Weinig moulders run by some of the most experienced operators in the industry produce top quality mouldings in exceptionally short turnaround time.

Surface 4 Sides (S4S)

Surface 4 Sides produces the highest quality finish for dimensional stock. Ripped and surfaced lumber is fed through one of our high-speed moulders to produce a finished product that requires little or no sanding and adheres to very tight tolerances.

Priming

A new Cefla vacuum coater and IR oven high-speed priming line allow us to offer latex based priming on millwork. This is a cost-effective way to significantly reduce installation time and labor on site. Options include 1-coat primed, primed and buffed, or primed buffed primed.

Rip 2 Edges (R2E)

Purchasing rip 2 edge lumber is ideal for fixed size millwork applications such as mouldings and casework. Rip 2 edge lumber can be fed directly into a moulder, saving you an extra step and limiting the potential for

excessive waste. Rip 2 edge lumber is typically delivered within two or three days on regular trucking routes.

Surfacing (S2S)

Our Oliver Straight-O-Planer essentially combines facing and surfacing into one operation. The Straight-O-Planer is able to remove minimal bend and twist in one pass while offering a high quality surface and precise thickness.

Straight Line Rip 1 Edge (SLR1E)

Straight line ripping is a simple, cost-effective way to achieve one straight edge from which to work.

Resaw

Having us resaw your lumber or moulding blanks is an ideal way to greatly improve your yield when producing finished thicknesses of less than 5/8".



Our Cefla vacuum coater and high-speed priming line.





ALAN McILVAIN COMPANY

Hardwood Lumber & Custom Mouldings Since 1798



Alan McIlvain Lumber Co.
501 Market St.
Marcus Hook, PA 19061

www.alanmcilvain.com
sales@alanmcilvain.com

T (610) 485-6600
T (800) 523-4231

F (610) 485-0471
F (800) 232-1798